



EQUIPAGGIAMENTI
TECNICI
LAVAGGIO

TESTINE ROTANTI
MOD. MI63



4 06

12.9406.00

06/04/09

MI63

MANUALE D'ISTRUZIONE
GENERAL INSTRUCTION BOOK

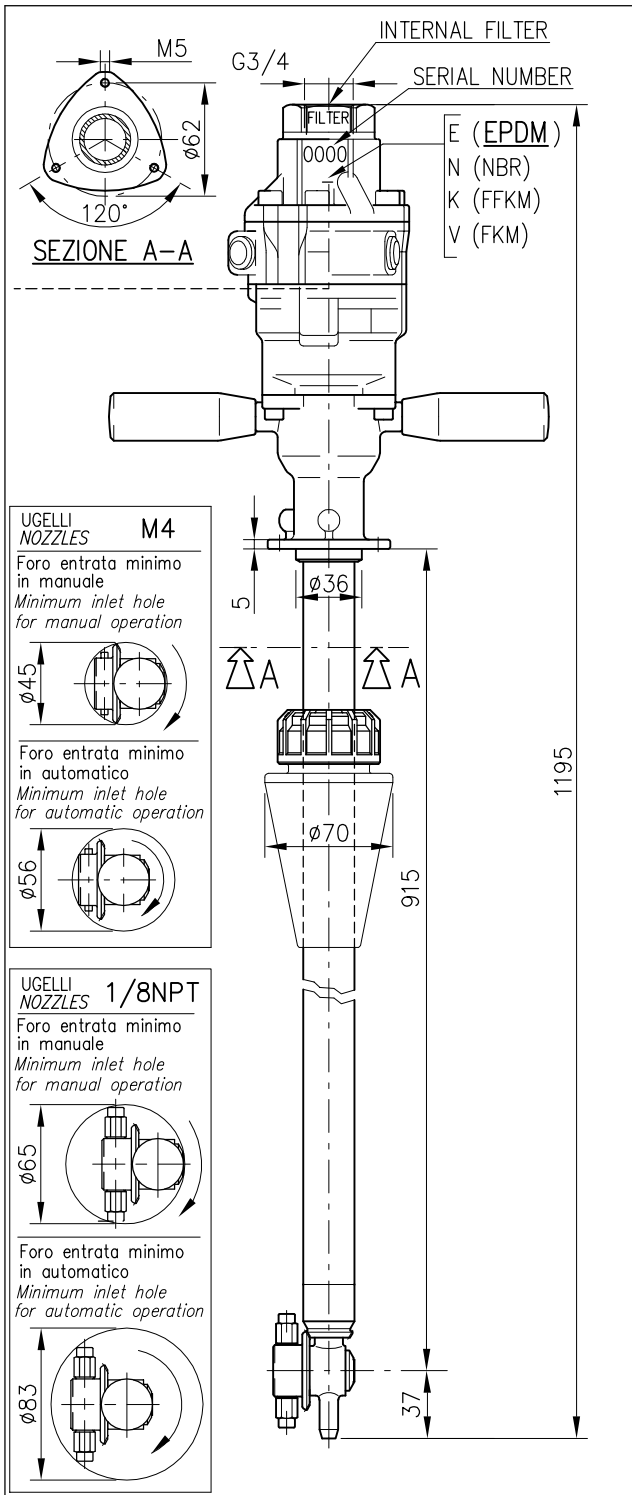

TESTINA AUTOMOVENTE PER PULIZIA CISTERNE

- Testina volumetrica, la velocità di rotazione è proporzionale alla portata in ingresso.
- Lavaggio superfici interne di contenitori e serbatoi.
- Portata ridotta, alta pressione, elevata forza di impatto.
- Copertura orbitale completa degli interni.
- Minimo ingombro radiale che ne permette l'introduzione attraverso passaggi ridotti.

- Velocità di rotazione indipendente dalla temperatura dell'acqua.
- Filtro in entrata.
- Costruzione in acciaio inox.
- Idonea per impiego settore alimentare.

ATTENZIONE !

- La Testina STANDARD è fornita di guarnizioni (DINAMICHE) in PTFE + O-Ring EPDM.
- Lubrificare esclusivamente con GRASSO SILICONICO codice: 14.6552.00
- Per l'utilizzo di liquidi detergenti, additivi chimici ecc. non compatibili con le guarnizioni standard è indispensabile contattare il nostro UFFICIO TECNICO.
- A richiesta le guarnizioni (DINAMICHE) O-RING sono disponibili anche in diverso materiale, NBR-FFKM(kalrez)-FKM(viton).
- Le guarnizioni (STATICHE) sono in FKM (viton).

SELF ROTATING CLEANING HEAD

- This is a self-propelled tank cleaning head: when the flow rate increases, the head rotates faster.
- Cleaning of interior surfaces of tanks and drums.
- Reduced flow, high pressure, high cleaning impact.
- Complete orbital coverage of all interior surfaces.
- Small spray turret that fits through reduced tank opening.
- Rotating speed independent from water temperature.
- Inlet filter.
- Stainless steel construction.
- Suitable for utilization in food industry.

ATTENTION !

- The STANDARD Tank cleaning head is supplied with seals (DYNAMIC) in PTFE + O-Ring EPDM.
- Lubricate ONLY with SILICONE GREASE P/N: 14.6552.00
- For use with Detergent liquid, Chemical additives etc that are not compatible with the standard seals, it is essential to contact our TECHNICAL OFFICE for further information.
- On request, the O-RING seals (DYNAMIC) are available in different materials such as NBR-FFKM(kalrez)-FKM(viton).
- The STATIC seals are in FKM (viton).

ATTENZIONE: NON UTILIZZARE
L'APPARECCHIO PRIMA DI AVER LETTO
QUESTO MANUALE DI ISTRUZIONE

CAUTION: DO NOT USE THE
CLEANING HEAD BEFORE HAVING READ
THE INSTRUCTION BOOK

CARATTERISTICHE TECNICHE

TECHNICAL SPECIFICATIONS

- PRESSIONE NOMINALE <i>RATED PRESSURE</i>	30÷140 bar – 3÷14 MPa (435÷2000 psi)	
- PRESSIONE CONSENTITA <i>PERMISSIBLE PRESSURE</i>	160 bar – 16 MPa (2300 psi)	
- PORTATA <i>FLOW RATE</i>	15 – 40 l/min (4–10.5 USGp.m.)	
- TEMPERATURA MASSIMA ACQUA <i>MAX WORKING TEMPERATURE</i>	0–90°C (32–195°F)	
- PESO <i>WEIGHT</i>	6.85 kg (241,6 oz) (1/8NPT)	6.8 kg (239,8 oz) (M4)
- FREQUENZA ROTAZIONE ASSE PRINCIPALE <i>MAIN AXIS ROTATING SPEED</i>	10–16 giri/min (RPM)	
- ATTACCO ALIMENTAZIONE ACQUA <i>INLET CONNECTION SIZE</i>	G 3/4"	
- ATTACCO UGELLI (2 o 4) <i>NOZZLES CONNECTION (2 or 4)</i>	1/8 NPT	M4

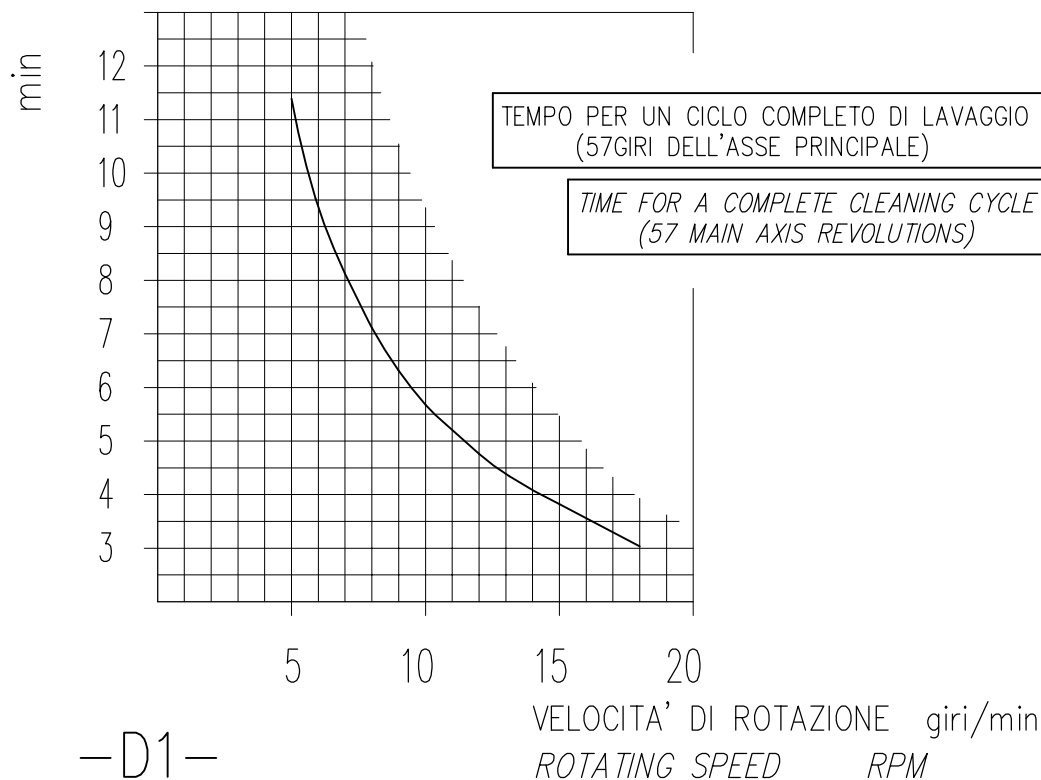

ACCESSORI

ACCESSORIES

- COPERCHIO CHIUSURA ACCIAIO INOX: <i>STAINLESS STEEL COVER:</i>	DIA. 590mm (23 inches)
---	------------------------

CADUTA DI PRESSIONE IN FUNZIONE DELLA PORTATA
 LOSS OF PRESSURE IN RELATION TO FLOW

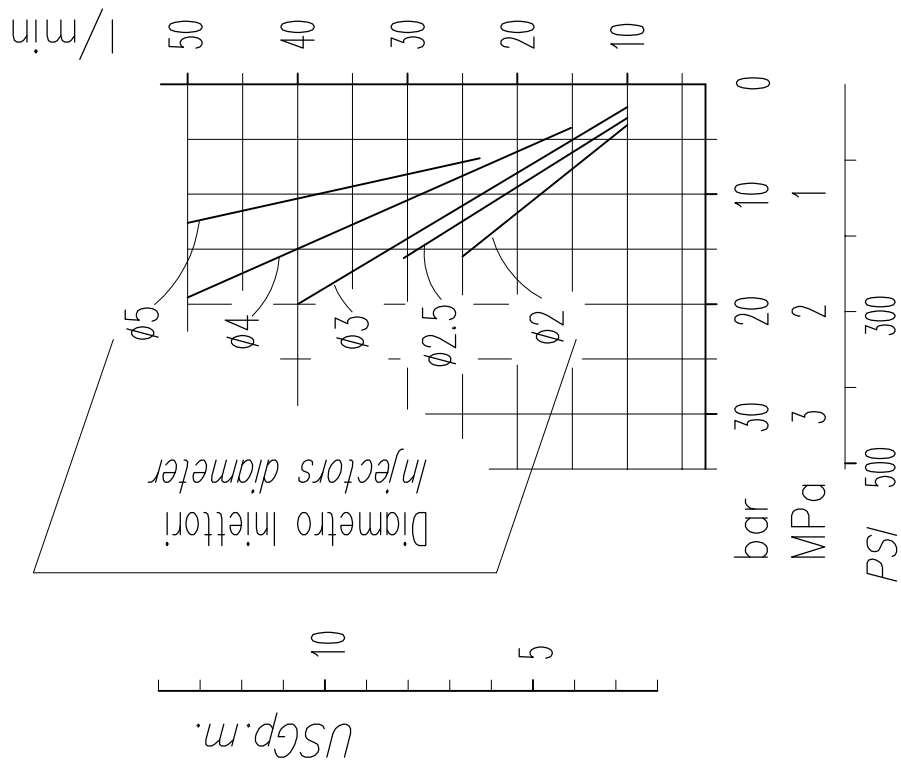

VARIAZIONE DEI GIRI IN FUNZIONE DELLA PORTATA
 RPM VARIATION IN RELATION TO FLOW

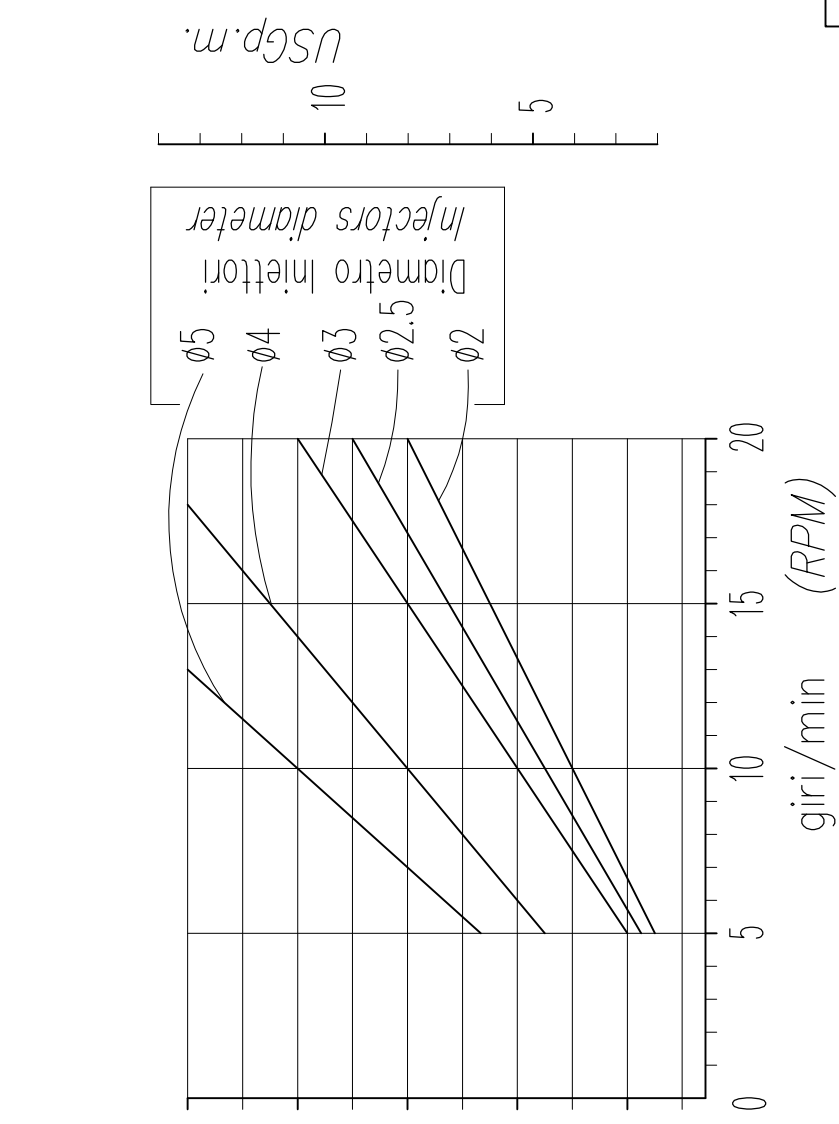

MI63





P.A. – S.p.A. – EQUIPAGGIAMENTI TECNICI DEL LAVAGGIO

VIA MILANO, 13 – CASELLA POSTALE 115 – 42048 RUBIERA (REGGIO EMILIA) – ITALY
 Tel. +39 0522 623611 – Fax. +39 0522 629600 – R.E.A. RE 156319 – R.I. RE11535 – Mecc. RE 013446
 C.F. e P. IVA 01035950359 – Cap. Soc. i.v. € 750.000,00 – Codice Identificativo C.E.E. IT 01035950359
 ART. 2497 – BIS C.C. DIREZIONE E COORDINAMENTO BENETTI srl R.I. TRIB. DI RE 01480690351
 Web: <http://www.pa-etl.it> – E-mail: info@pa-etl.it



Dichiarazione di conformità – Declaration of conformity

Attrezzatura – Equipment:		ACCESSORIO A PRESSIONE PRESSURE EQUIPMENT	
Modello – Type:		MI63 e MI85	
Fluido – Fluid:		ACQUA CALDA E DETERGENTI HOT WATER AND DETERGENTS	
Gruppo fluidi: Group of Fluid:	II	Temperatura min. e max. ammissibile Permissible Temperature (min/max °C)	0 ÷ 90°C

Procedura di valutazione della conformità

Conformity Assessment Procedure Followed

Allegato: Annex:		Modulo: Module:	
Organismo notificato - Notified Body:			-----
Attestato CE del tipo - EC Type - Examination Certificate:			-----
Marcatura CE del fabbricante - Manufacturer's CE Marking:			-----
Organismo Notificato per il Sistema Qualità: Notified Body for Assessment of Quality System:			-----
Organismo di certificazione per il Sistema di Qualità: Notified Body for Certification of Quality System:			DNV-GL
Norme europee applicate: Harmonized Standards applied :			CEI EN 60335-2-79:2015 UNI EN 1829-1:2010
Codici di calcolo: Design Calculations Applied:			

Libretto uso e manutenzione presente nel sito web Operation and Maintenance Manual available on Website	Il Fabbricante PA SpA The Manufacturer PA SpA	
--	--	--

25.4600.20 MI63-50 test.mot.idrocic.,iniett.2mm
 25.4600.24 MI63-45 test.mot.idrocic.,iniett.2mm
 25.4600.30 MI63-50 test.mot.idrocic.,iniett.3mm

25.4600.40 MI63-50 test.mot.idrocic.,iniett.4mm
 25.4600.50 MI63-50 test.mot.idrocic.,iniett.5mm
 25.4902.25 MI63A-50-1/8 tes.id/cin.inie.2,5mm Atex 2460

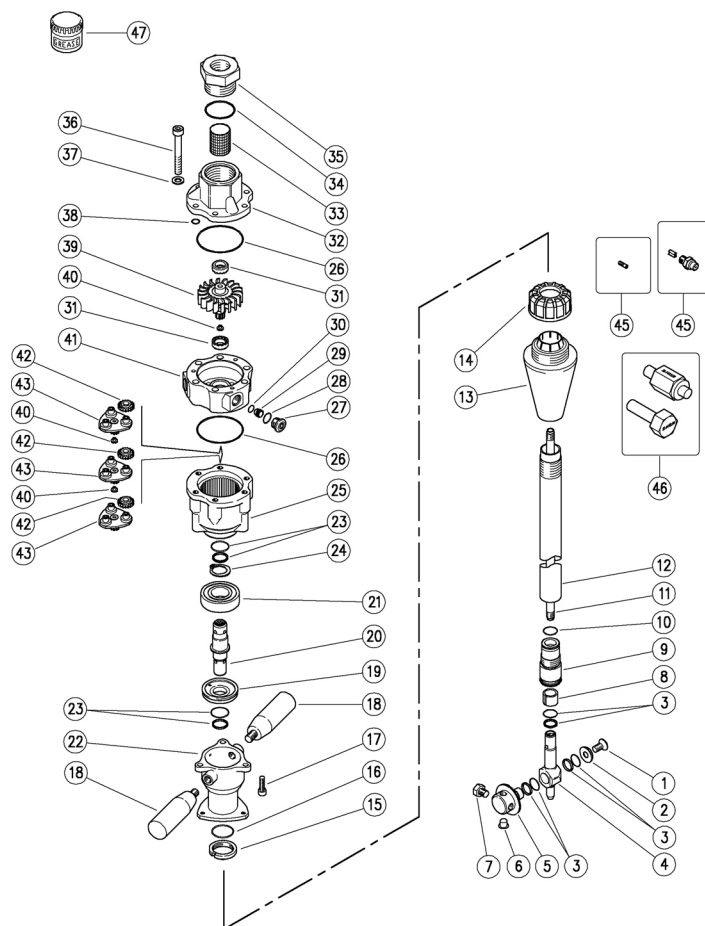

Pos.	Codice	Descrizione	Q.tà	K1	K2	K3	K4
1	16.1954.12R	Vite DIN7991 M8x12 mm inox	1				10
2	80.0015.51R	Rosetta svas. 8,5x22x4,5mm inox	1				3
3	10.2030.00R	Guarn. stelo 15x20x2,2 mm +OR	3	•			4
4	80.0005.52R	Respingente M10 inox	1				1
5	80.0014.51R	Pign.p/ug. z.57, 4x1/8Npt F in. (1)	1				1
5	80.0016.51R	Pign.p/ug. z.57, M4 FFFF in. (2)	1				1
6	15.3710.18R	Tappo G1/8" plast. (1)	2				4
6	15.3704.00R	Tappo M4 plast. (2)	2				4
7	15.3711.18R	Tappo inox 303 1/8M Npt s/testa (1)	2				4
7	16.1830.00R	Vite DIN912 M4x8 mm inox (2)	2				10
8	80.0009.85R	Boccola a. 15x19x14,8mm PTFE	1	•			5
9	80.0027.23R	Pignone z.34 inox+Bocc.a.15mm	1				1
10	10.3184.10R	An.OR 2,62x18,72 mm Vi 70	1	•			10
11	80.0003.56R	Tubo M10x1 MM 894mm inox	1				1
12	80.0052.56R	Tubo M28x1 M 895mm inox	1				1
13	80.0021.84R	Tappo conico TPEs nero	1		•		3
14	80.0316.84R	Ghiera PP nera	1		•		10
15	80.0012.51R	Ghiera M28x1 inox	1				2
16	10.3205.10R	An.OR 2,62x26,64 mm Vi 70	1	•			10
17	16.1896.20R	Vite DIN912 M6x20 mm inox	3				10
18	13.0600.00R	Manopola M10x15 mm	2				2
19	80.0233.51R	An. distanziale 18x46,8x10,8mm inox	1				1
20	80.0232.51R	Albero dentato inox	1				1
21	11.4420.47R	Cuscinetto 20x47x14 mm - 2RS inox	1	•			2
22	80.0231.52R	Corpo manicotto inox	1				1
23	10.2030.18R	Guarn. stelo 18x23x2 mm +OR Epdm	2	•			5
24	10.1020.05R	An. elast. E 20 inox	1		•		10
25	80.0207.52R	Corona z.50 inox	1				1

Pos.	Codice	Descrizione	Q.tà	K1	K2	K3	K4
26	10.3080.58R	An.OR 1,78x56,87 mm Vi 70	2	•			10
27	80.0219.51R	Tappo EI M14x1 inox	3				3
28	10.3060.10R	An.OR 1,78x12,42 mm Vi 70	3	•			10
29	80.0221.51R	Iniettore 2mm inox	3				3
29	80.0222.51R	Iniettore 3mm inox (3)	3				3
29	80.0223.51R	Iniettore 4mm inox (4)	3				3
29	80.0224.51R	Iniettore 5mm inox (5)	3				3
30	10.3003.00R	An.OR 1x8 mm	3	•			10
31	80.0212.84R	Boccola plastica	2		•		10
32	80.0201.52R	Collettore inox	1				1
33	28.0014.53R	Rete 38mesh-400µm inox	1				10
34	10.3208.36R	An.OR 2,62x36,17 mm Vi 70	1	•			5
35	80.0217.51R	Racc. M40x2 M -G3/4F inox	1				1
36	16.1955.60R	Vite DIN912 M8x60 mm inox	6				10
37	14.3573.00R	Rosetta secur. 8,4x2 mm inox	6				10
38	10.3109.93R	An.OR 2,4x8,3 mm Vi 70	3	•			10
39	80.0203.52R	Turbina inox	1				1
40	80.0213.84R	Perno rasamento plast.	3		•		10
41	80.0202.52R	Statore inox	1				1
42	80.0204.38R	Satellite z.19 bronzo	9		•		9
43	80.0205.00R	Portasatelliti+3 perni inox	3				1
45	16.1363.45R	Ug. inox 1/8M Npt+ventol. 00.045 **	2-4				10
45	25.1091.51R	Ugello 025 - M4 inox rosa ***	2-4				10
45	25.1190.51R	Ugello 02 - M4 inox verde chiaro ***	2-4				10
45	25.1093.51R	Ugello 035 - M4 inox marrone ***	2-4				10
46	25.4631.24	Kit Attr. Montag. Guarn.-MI63 3pz. ***	1				1
47	14.6552.00R	Grass.silicone-teflon-30g.>tutti imp. ***	1				2

** Varie misure disponibili

*** Su richiesta

Kit	Codice	Descrizione	
K1	25.4608.24	Kit ric. MI63 9x1pz.	1
K2	25.4630.24	Kit ric. MI63 - MI85 6x1pz.	1
K3	80.0020.00	Completo tappo conic. fissaggio	1

(1) 25.4600.20 (2) 25.4600.24 (3) 25.4600.30 (4) 25.4600.40 (5) 25.4600.50

25.4600.20 MI63-50 Tank cl.,hydr.-driv.,2mm-inject.
 25.4600.24 MI63-45 Tank cl.,hydr.-driv.,2mm-inject.
 25.4600.30 MI63-50 Tank cl.,hydr.-driv.,3mm-inject.

25.4600.40 MI63-50-1/8 inject.4,00mm
 25.4600.50 MI63-50 Tank cl.,hydr.-driv.,5mm-inject.
 25.4902.25 MI63A-50 Tank cl.,hy.-driv.,2,5mm-Atex 2460

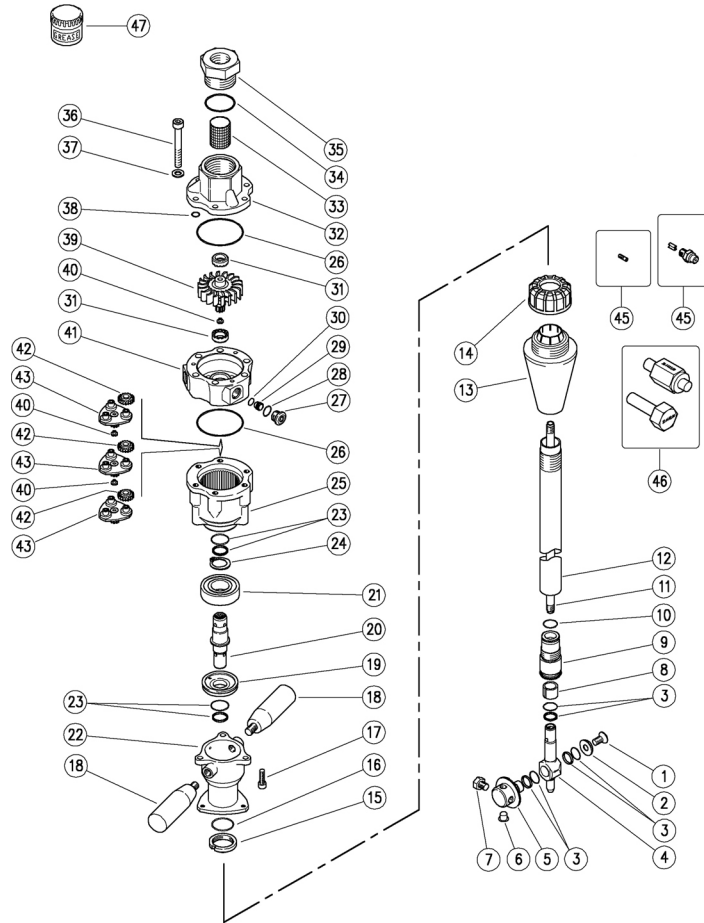

Pos.	P/N	Description	Q.ty	K1	K2	K3	K4	
1	16.1954.12R	Screw, DIN7991 M8x12 mm Sst.	1					10
2	80.0015.51R	C/sunk washer, 8,5x22x4,5mm Sst.	1					3
3	10.2030.00R	Stem seal, 15x20x2,2 mm +O-ring	3	•				4
4	80.0005.52R	Buffer, M10 Sst.	1					1
5	80.0014.51R	Nzl hold. pinio.z.57, 4x1/8Npt F sst. (1)	1					1
5	80.0016.51R	Nzl hold. pinion, z.57, M4 FFFF Sst. (2)	1					1
6	15.3710.18R	Plug, 1/8" Bsp plast. (1)	2					4
6	15.3704.00R	Plug, M4 plast. (2)	2					4
7	15.3711.18R	Grub screw, 303 Sst. 1/8M Npt (1)	2					4
7	16.1830.00R	Screw, DIN912 M4x8 mm Sst. (2)	2					10
8	80.0009.85R	Bushing, opn. 15x19x14,8mm PTFE	1	•				5
9	80.0027.23R	Pinion.34 Sst+Bushing,opn.15mm	1					1
10	10.3184.10R	O-ring, 2,62x18,72 mm Vi 70	1	•				10
11	80.0003.56R	Tube, M10x1 MM 894mm Sst.	1					1
12	80.0052.56R	Tube, M28x1 M 895mm Sst.	1					1
13	80.0021.84R	Tapered plug, TPEs black	1		•			3
14	80.0316.84R	Ring nut, PP black	1		•			10
15	80.0012.51R	Ring nut, M28x1 Sst.	1					2
16	10.3205.10R	O-ring, 2,62x26,64 mm Vi 70	1	•				10
17	16.1896.20R	Screw, DIN912 M6x20 mm Sst.	3					10
18	13.0600.00R	Knob M10x15 mm	2					2
19	80.0233.51R	Spacer ring, 18x46,8x10,8mm Sst.	1					1
20	80.0232.51R	Geared shaft, Sst.	1					1
21	11.4420.47R	Ball-bearing, 20x47x14 mm - 2RS Sst.	1	•				2
22	80.0231.52R	Housing sleeve, Sst.	1					1
23	10.2030.18R	Stem seal, 18x23x2 mm +O-ring Epdm	2	•				5
24	10.1020.05R	Snap ring, E 20 Sst.	1	•				10
25	80.0207.52R	Ring gear, z.50 Sst.	1					1

Pos.	P/N	Description	Q.ty	K1	K2	K3	K4	
26	10.3080.58R	O-ring, 1,78x56,87 mm Vi 70	2	•				10
27	80.0219.51R	Plug, int.hex., M14x1 Sst.	3					3
28	10.3060.10R	O-ring, 1,78x12,42 mm Vi 70	3	•				10
29	80.0221.51R	Injector, 2mm Sst.	3					3
29	80.0222.51R	Injector, 3mm Sst. (3)	3					3
29	80.0223.51R	Injector, 4mm Sst. (4)	3					3
29	80.0224.51R	Injector, 5mm Sst. (5)	3					3
30	10.3003.00R	O-ring, 1x8 mm	3	•				10
31	80.0212.84R	Bushing, plast.	2		•			10
32	80.0201.52R	Manifold, Sst.	1					1
33	28.0014.53R	Net, 38mesh-400µm Sst.	1					10
34	10.3208.36R	O-ring, 2,62x36,17 mm Vi 70	1	•				5
35	80.0217.51R	Coupl., M40x2 M -3/4F Bsp Sst.	1					1
36	16.1955.60R	Screw, DIN912 M8x60 mm Sst.	6					10
37	14.3573.00R	Safet. washer, 8,4x2 mm Sst.	6					10
38	10.3109.93R	O-ring, 2,4x8,3 mm Vi 70	3	•				10
39	80.0203.52R	Turbine, Sst.	1					1
40	80.0213.84R	Shim pin, plast.	3		•			10
41	80.0202.52R	Stator, Sst.	1					1
42	80.0204.38R	Planetary gear, z.19 brz	9	•				9
43	80.0205.00R	Planetary gear holder+3 pins, Sst.	3					1
45	16.1363.45R	Nzl, sst,1/8M Npt+guid.vane 00.045 **	2-4					10
45	25.1091.51R	Nozzle, 025 - M4 Sst. pink ***	2-4					10
45	25.1190.51R	Nozzle, 02 - M4 Sst. light green ***	2-4					10
45	25.1093.51R	Nozzle, 035 - M4 Sst. brown ***	2-4					10
46	25.4631.24	Seal Setup Tool Kit - MI63 3pcs. ***	1					1
47	14.6552.00R	Teflon silicon grease x30g.>All ***	1					2

** Different measures available

*** On request

Kit	P/N	Description	
K1	25.4608.24	Spares Kit - M163 9x1pcs.	1
K2	25.4630.24	Spares Kit - M163 - M185 6x1pcs.	1
K3	80.0020.00	Tapered plug -M63	1

(1) 25.4600.20 (2) 25.4600.24 (3) 25.4600.30 (4) 25.4600.40 (5) 25.4600.50