

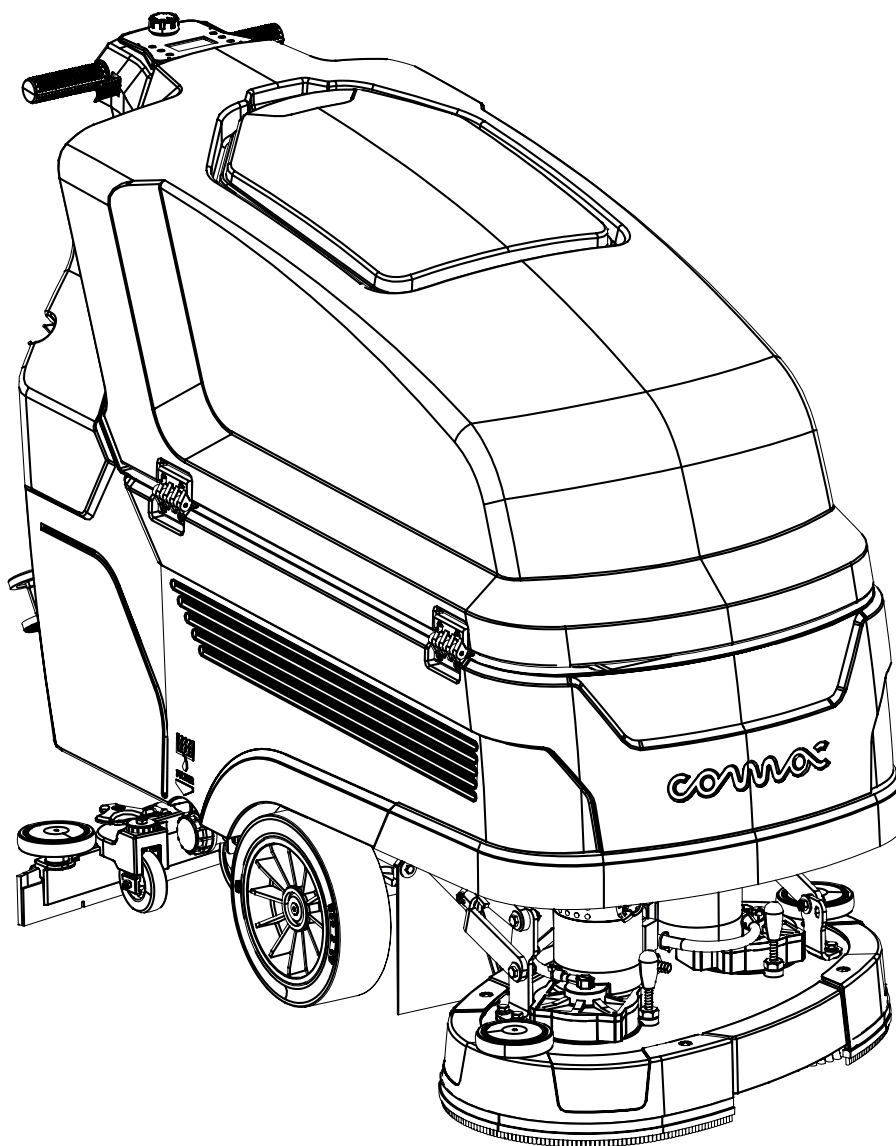

# VEGO 2019



SCRUBBING MACHINES

## USE AND MAINTENANCE MANUAL





## CONTENTS

<b>CONTENTS</b> .....	<b>3</b>
<b>LOCATING THE MAIN MACHINE COMPONENTS</b> .....	<b>5</b>
<b>GENERAL DESCRIPTION</b> .....	<b>6</b>
GENERAL SAFETY REGULATIONS.....	6
SYMBOLS USED IN THE MANUAL.....	6
PURPOSE AND CONTENT OF THE MANUAL.....	7
TARGET GROUP.....	7
PRESERVATION OF THE USER.....	7
ON CONSIGNMENT OF THE MACHINE.....	7
INTRODUCTORY COMMENT.....	7
IDENTIFICATION DATA.....	7
TECHNICAL DESCRIPTION.....	7
INTENDED USE.....	7
SAFETY.....	7
REGULATIONS.....	7
SERIAL NUMBER PLATE.....	8
<b>TECHNICAL DATA</b> .....	<b>8</b>
<b>SYMBOLS AND LABELS USED IN THE MACHINE</b> .....	<b>9</b>
SYMBOLS USED ON THE MACHINE.....	9
LABELS USED ON THE MACHINE.....	10
SYMBOLS USED ON THE CONTROL PANEL.....	11
SYMBOLS USED ON THE CONTROL PANEL.....	11
<b>PREPARATION OF MACHINE</b> .....	<b>12</b>
HANDLING THE PACKAGED MACHINE.....	13
HOW TO UNPACK THE MACHINE (versions without PM).....	13
HOW TO UNPACK THE MACHINE (versions with PM).....	13
HOW TO MOVE THE MACHINE.....	14
MACHINE SAFETY.....	14
TYPE OF BATTERY TO BE USED.....	14
INSERTING THE BATTERIES IN THE MACHINE.....	14
BATTERY MAINTENANCE AND DISPOSAL.....	15
RECHARGING THE BATTERIES.....	15
INSERTING WATER SYSTEM FILTER.....	16
ASSEMBLING THE BRUSH (SCRUBBING VERSION).....	16
ASSEMBLING THE BRUSH (SWEEPING VERSION).....	16
ASSEMBLING THE ABRASIVE PAD (ORBITAL VERSION).....	16
ASSEMBLING THE SQUEEGEE BODY.....	17
FILLING THE SOLUTION TANK WITH WATER.....	17
DETERGENT SOLUTION.....	17
<b>PREPARING TO WORK</b> .....	<b>18</b>
<b>STARTING WORK</b> .....	<b>19</b>
BATTERY CHARGE LEVEL INDICATOR.....	20
HOUR METER.....	21
SCRUBBING WITH DRYING.....	21
SCRUBBING WITHOUT DRYING.....	21
DRYING.....	22
ECO MODE.....	23
ADJUSTING THE DETERGENT SOLUTION (versions without CDS system).....	23
ADJUSTING THE DETERGENT SOLUTION (versions with CDS system).....	23
SPEED ADJUSTMENT.....	23
REVERSE ACTIVATION - DEACTIVATION.....	24
VACUUM WAND KIT.....	24
SPRAY GUN KIT.....	25
EXTRA BRUSH HEAD PRESSURE.....	25
EMERGENCY BUTTON.....	25
ALARM SCREEN.....	25

TAG INSERTION (CFC VERSIONS) .....	26
OVERFLOW DEVICE .....	26
<b>AT THE END OF THE WORK.....</b>	<b>26</b>
<b>RECOMMENDED MAINTENANCE OPERATIONS .....</b>	<b>27</b>
CLEANING THE SQUEEGEE BODY.....	29
CLEANING THE DEBRIS HOPPER (SWEEPING VERSION) .....	29
CLEANING THE BRUSH HEAD BRUSHES (SCRUBBING VERSION) .....	29
CLEANING THE BRUSH HEAD BRUSHES (SWEEPING VERSION) .....	29
DRAINING THE RECOVERY TANK .....	30
CLEANING THE RECOVERY TANK FILTERS .....	30
CLEANING THE VACUUM TUBE.....	30
EMPTYING THE SOLUTION TANK.....	30
CLEANING THE WATER SYSTEM FILTER.....	30
CLEANING THE DETERGENT TANK (CDS VERSIONS).....	31
<b>EXTRAORDINARY MAINTENANCE WORK .....</b>	<b>31</b>
REPLACING THE SQUEEGEE BODY RUBBER BLADES .....	31
REPLACING THE BRUSH (SCRUBBING VERSION).....	32
REPLACING THE BRUSH (SWEEPING VERSION).....	32
<b>ADJUSTMENT INTERVENTIONS.....</b>	<b>32</b>
ADJUSTING THE SQUEEGEE BODY'S RUBBER BLADES .....	32
<b>CHOOSING AND USING BRUSHES .....</b>	<b>33</b>
<b>TROUBLESHOOTING .....</b>	<b>34</b>
<b>EC DECLARATION OF CONFORMITY .....</b>	<b>36</b>

## LOCATING THE MAIN MACHINE COMPONENTS

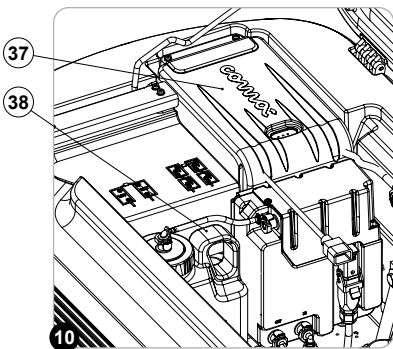
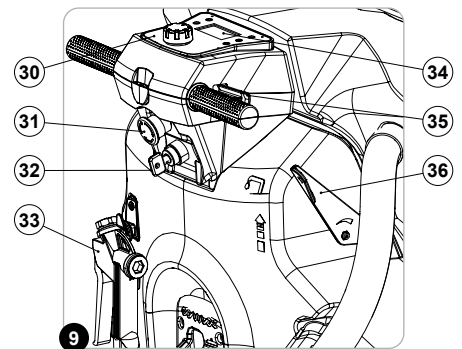
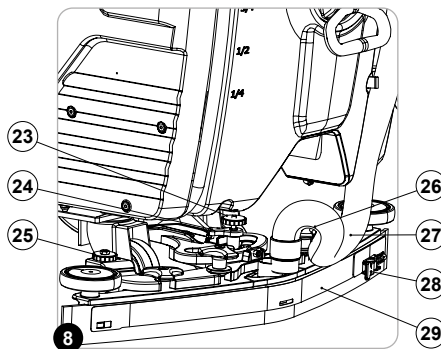
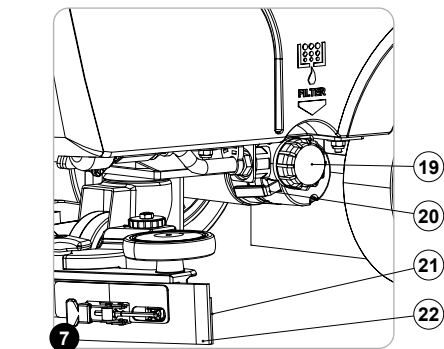
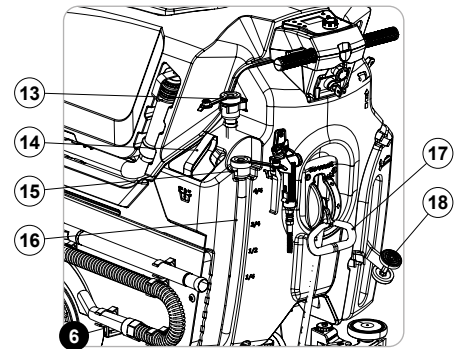
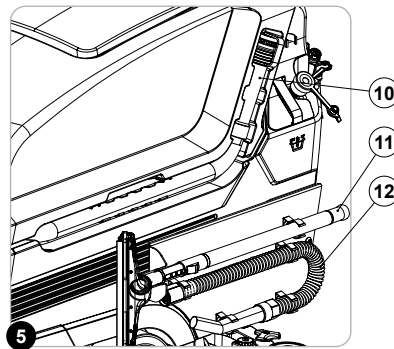
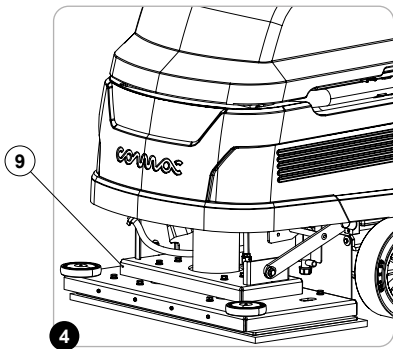
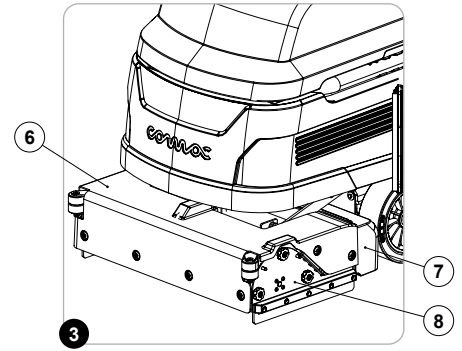
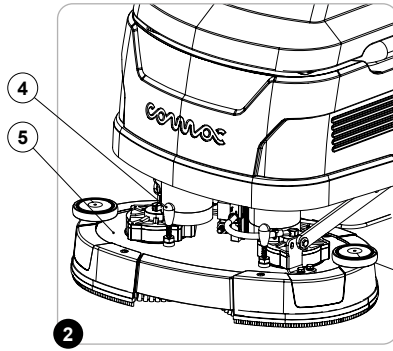
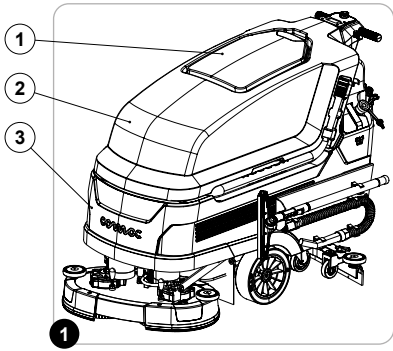

- 12. Liquid vacuum wand kit vacuum tube, SST version (Fig.5).
- 13. Solution tank quick filling tube (Fig.6).
- 14. Solution tank filler cap/measuring device inlet (Fig.6).
- 15. Solution tank level indicator tube (Fig.6).
- 16. Solution tank level indicator ball (Fig.6).
- 17. Squeegee control lever (Fig.6).
- 18. Brush head control pedal, versions without PM (Fig.6).
- 19. Detergent solution filter (Fig.7).
- 20. Traction motor electric brake control lever (Fig.7).
- 21. Squeegee body front rubber blade (Fig.7).
- 22. Squeegee body rear rubber blade (Fig.7).
- 23. Squeegee body tilt adjustment lever stop knob (Fig.8).
- 24. Squeegee body tilt adjustment lever (Fig.8).
- 25. Squeegee body height adjustment lever (Fig.8).
- 26. Squeegee body fixing knob (Fig.8).
- 27. Lower squeegee body fixing knob (Fig.8).
- 28. Rear rubber blade fixing blade uncoupling lever (Fig.8).
- 29. Rear rubber blade fixing blade (Fig.8).
- 30. Control panel (Fig.9).
- 31. Emergency button (Fig.9).
- 32. Key-operated main switch (Fig.9).
- 33. Tank cleaning gun kit, SST version (Fig.9).
- 34. Control display (Fig.9).
- 35. Dead man's lever (Fig.9).
- 36. Detergent solution tap control lever (Fig.9).
- 37. On-board battery charger, CB versions (Fig.10).
- 38. Chemical product tank, CDS versions (Fig.10).

The machine's main components are the following:

- 1. Recovery tank cover (Fig.1).
- 2. Recover tank (Fig.1).
- 3. Solution tank (Fig.1).
- 4. Locking pin for the brush holder rotation plate (Fig.2).
- 5. Scrubbing version brush head (Fig.2).
- 6. Sweeping version brush head (Fig.3).
- 7. Debris hopper (Fig.4).
- 8. Front brush cover carter (Fig.3).
- 9. Orbital version brush head (Fig.4).
- 10. Recovery tank outlet pipe (Fig.5).
- 11. Liquid vacuum wand kit extension tube, SST version (Fig.5).















## GENERAL DESCRIPTION

The descriptions contained in this document are not binding. The company therefore reserves the right to make any modifications at any time to elements, details, or accessory supply, as considered necessary for reasons of improvement or manufacturing/commercial requirements. The reproduction, even partial, of the text and drawings contained in this document is prohibited by law. **The company reserves the right to make any technical and/or supply modifications. The images are for reference purposes only, and are not binding in terms of design and supply.**

## GENERAL SAFETY REGULATIONS

Before using the machine, please read the following document carefully and follow the instructions contained herein, along with the instructions in the document supplied with the machine itself, "GENERAL SAFETY REGULATIONS" (document code 10083659).

## SYMBOLS USED IN THE MANUAL

	<b>Open book symbol with an "i":</b> Indicates the need to consult the instruction manual.
	<b>Open book symbol:</b> Tells the operator to read the user manual before using the device.
	<b>Covered place symbol:</b> The operations preceded by this symbol must always be carried out in a dry, covered area.
	<b>Information symbol:</b> Indicates additional information for the operator, to improve the use of the device.
	<b>Warning symbol:</b> Carefully read the sections preceded by this symbol meticulously following the instructions indicated for the safety of the operator and the device.
	<b>Danger symbol (corrosive substances):</b> The operator should always wear protective gloves to avoid the risk of serious injury to the hands caused by corrosive substances.
	<b>Danger symbol (battery acid leakage):</b> Indicates the danger of leaking acid or acid fumes from the batteries while they are being recharged.
	<b>Danger symbol (moving carriages):</b> Indicates that the packed product should be handled with suitable carriages that conform to legal requirements.
	<b>Mandatory room ventilation symbol:</b> Informs the operator that the room must be ventilated while the batteries are being recharged.
	<b>Symbol indicating the compulsory use of protective gloves:</b> Indicates that the operator should always wear protective gloves, to avoid the risk of serious injury to his hands from sharp objects.
	<b>Symbol indicating the compulsory use of tools:</b> Informs the operator of the need to use tools not included with the machine.
	<b>Symbol indicating a treading ban:</b> Informs the operator that it is forbidden to tread on machine components, as this could lead to serious injury.
	<b>Recycling symbol:</b> Tells the operator to carry out the operations in compliance with environmental regulations in force in the place where the appliance is being used.
	<b>Disposal symbol:</b> Carefully read the sections marked with this symbol for disposing of the appliance.

## PURPOSE AND CONTENT OF THE MANUAL

The aim of this manual is to provide customers with all the information needed to use the machine in the safest, most appropriate and most autonomous way. This includes information concerning technical aspects, safety, operation, downtime, maintenance, spare parts and scrapping. The operators and qualified technicians must carefully read the instructions in this manual before carrying out any operations on the machine. If in doubt about the correct interpretation of the instructions, contact your nearest COMAC Customer Service Centre to obtain the necessary clarifications.

## TARGET GROUP

This manual is written both for operators and for qualified machine maintenance technicians. Operators must not perform operations that should be carried out by qualified technicians. The manufacturer is not liable for damages resulting from failure to comply with this veto.

## PRESERVATION OF THE USER

The Use and Maintenance Manual must be stored in its special pouch close to the machine, protected from liquids and anything else that could compromise its legibility.

## ON CONSIGNMENT OF THE MACHINE

When the machine is consigned to the customer, an immediate check must be performed to ensure all the material mentioned in the shipping documents has been received, and also to check the machine has not suffered damage during transportation. If this is the case, the carrier must ascertain the extent of the damage at once, informing our customer service office. It is only by prompt action of this type that the missing material can be obtained, and compensation for damage successfully claimed.

## INTRODUCTORY COMMENT

Any floor scrubbing machine can only work properly and effectively if used correctly and kept in full working order by performing the maintenance operations described in the attached documentation. We therefore suggest you read this instruction booklet carefully and read it again whenever difficulties arise while using the machine. If necessary, remember that our assistance service (organised in collaboration with our dealers) is always available for advice or direct intervention.

## IDENTIFICATION DATA

For technical assistance or to request replacement parts, always give the model, the version and the serial number (written on the relevant plate).

## TECHNICAL DESCRIPTION

The **Vega 2019** is a floor scrubbing machine that is capable of handling a wide variety of floors and types of dirt thanks to the mechanical action of one or two brushes and the chemical action of a water-detergent solution. As it advances, it collects the dirt removed, as well as the detergent solution not absorbed by the flooring itself. **The machine must only be used for this purpose.**

## INTENDED USE

This scrubbing machine was designed and built for the cleaning (scrubbing and drying) of smooth, compact flooring in the commercial, residential and industrial sectors by a qualified operator in proven safety conditions. The scrubbing machine is not suitable for cleaning rugs or carpet floors. It is only suitable for use in closed (or at least covered) places.

 **ATTENTION:** the machine is not suitable for use in the rain, or under water jets.

 **IT IS FORBIDDEN** to use the machine in environments with an explosive atmosphere to clean dangerous powders or flammable liquids. In addition, it is not suitable as a means of transport for people or objects.

## SAFETY

Operator cooperation is paramount for accident prevention. No accident prevention programme can be effective without the full cooperation of the person directly responsible for machine operation. The majority of occupational accidents that happen either in the workplace or whilst moving are caused by failure to respect the most basic safety rules. An attentive, careful operator is most effective guarantee against accidents and is fundamental in order to implement any prevention programme.

## REGULATIONS

All references to forwards and backwards, front and rear, right and left indicated in this manual should be understood as referring to the operator in a driving position with his hands on the steering wheel.

## SERIAL NUMBER PLATE

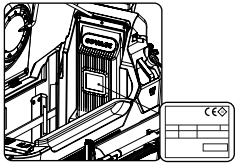

The serial number plate is positioned above the electrical system cover carter inside the machine. It indicates the general machine characteristics, in particular the serial number. The serial number is a very important piece of information and should always be provided together with any request for assistance or when purchasing spare parts. The serial number plate contains the following:

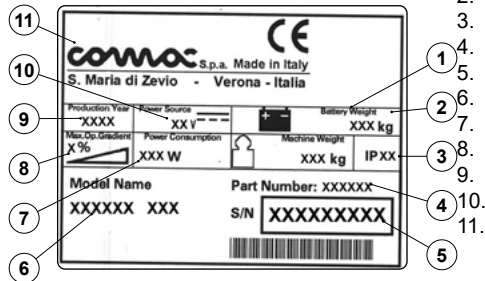

1. The weight of the batteries used to power the appliance (expressed in Kg).
2. The IP protection rating of the appliance.
3. The gross weight of the appliance (expressed in Kg).
4. The identification code of the appliance.
5. The serial number of the appliance.
6. The name of the appliance.
7. The nominal power consumed by the appliance (expressed in W).
8. The maximum grade that the appliance can handle during work activities (expressed in %).
9. The year in which the appliance was manufactured.
10. The nominal voltage of the appliance (expressed in V).
11. The commercial name of the appliance and the manufacturer's address.

## TECHNICAL DATA

TECHNICAL DATA	U/M [KMS]	VEGA 65 BT	VEGA 75 BT	VEGA 85 BT	VEGA 70 BT <sub>0</sub>	VEGA 70 BT <sub>0</sub>
Rated machine power	kW	1,5	1,7	1,7	1,4	1,6
Theoretical working capacity up to	m <sup>2</sup> /h	2425	2830	3145	2630	2370
Maximum working width	mm	655	765	850	710	640
Squeegee width	mm	785	885	985	885	885
Scrubbing brush head brush (Ø external bristles)	mm	340	400	440	-	-
Orbital brush head abrasive pad (width - length)	mm	-	-	-	710 - 355	-
Sweeping brush head brush (Ø external bristles - length)	mm	-	-	-	-	180 - 615
Electrical characteristics of the brush head motor	V / W	24 - 400	24 - 500	24 - 500	24 - 680	24 - 450
Single brush rpm	rpm	140	140	140	-	550
Number of oscillations of the abrasive pad	rpm	-	-	-	2000	-
Weight exerted on the floor by the brush head	kg	52	52	52	45	33
Traction motor electrical properties (voltage - power)	V / W	24 - 300	24 - 300	24 - 300	24 - 300	24 - 300
Maximum slope during work (GVW)	%	9	9	9	9	9
Maximum working speed	km/h	4,3	4,3	4,3	4,3	4,3
Suction motor electrical properties (voltage - power)	V / W	24 - 422	24 - 422	24 - 422	24 - 422	24 - 422
Vacuum on vacuum head	KPa	11,9	11,9	11,9	11,9	11,9
Maximum solution tank capacity	l	76	76	76	76	76
Maximum recovery tank capacity	l	113	113	113	113	113
Maximum detergent tank capacity (CDS versions)	l	3	3	3	3	3
Maximum debris hopper capacity	l	-	-	-	-	5
Minimum inversion footprint	mm	1600	1600	1600	1600	1600
Machine dimensions (length - height - width)	mm	1495	1515	1545	1390	1475
		1055	1055	1055	1055	1055
		785	885	985	885	885
Battery compartment dimensions (length - height - width)	mm	525	525	525	525	525
		385	385	385	385	385
		325	325	325	325	325
Machine weight when empty	kg	169	178	187	187	180
Transported machine weight	kg	297	306	315	315	307
GVW	kg	368	377	386	386	394
Sound pressure level in operator seat [ISO 11201] (L <sub>PA</sub> )	dB	<70	<70	69	69	69,6
Sound power level [IEC 60335-2-72; IEC 62885-9; ISO 3744] (L <sub>WA</sub> )	dB	<80	<80	80,27	80,27	85,43



TECHNICAL DATA	U/M [KMS]	VEGA 65 BT	VEGA 75 BT	VEGA 85 BT	VEGA 70 BT <sub>0</sub>	VEGA 70 BT <sub>0</sub>
Uncertainty $K_{pA}$	dB	1,5	1,5	1,5	1,5	1,5
Hand-arm vibrations [IEC 60335-2-72; IEC 62885-9; ISO 5349-1]	m/s <sup>2</sup>	<2,5	<2,5	<2,5	<2,5	<2,5
Vibration measurement uncertainty		4%	4%	4%	4%	4%

## SYMBOLS AND LABELS USED IN THE MACHINE

### SYMBOLS USED ON THE MACHINE

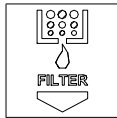

**Filter body position symbol:**

Located on the right-hand side of the machine to indicate the position of the detergent solution tank.



**Recovery tank drainage hose symbol - solution tank:**

Applied to the back left-hand side of the machine to identify the position of the solution tank drainage tube.

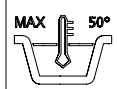

**Symbol for maximum temperature for filling the solution tank:**

Located on the left-hand side of the machine to indicate the maximum temperature of the water for filling the solution tank safely.



**Solution tank filling symbol:**

This is located on the rear left side of the machine's solution tank to indicate the amount of water or detergent solution in the tank. The symbol on the side indicates that the tank is full to about a quarter of its capacity.

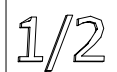

**Solution tank filling symbol:**

This is located on the rear left side of the machine's solution tank to indicate the amount of water or detergent solution in the tank. The symbol on the side indicates that the tank is full to about a half of its capacity.



**Solution tank filling symbol:**

This is located on the rear left side of the machine's solution tank to indicate the amount of water or detergent solution in the tank. The symbol on the side indicates that the tank is full to about three-quarters of its capacity.



**Solution tank filling symbol:**

This is located on the rear left side of the machine's solution tank to indicate the amount of water or detergent solution in the tank. The symbol on the side indicates that the tank is full.

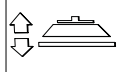

**Brush head command pedal position symbol (versions without PM):**

Located on the rear right-hand side of the machine to indicate the brush head control pedal.

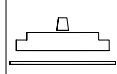

**Squeegee control lever position symbol:**

Used on the rear of the machine to indicate the squeegee control lever.

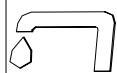

**Tap control lever position symbol:**

Used on the rear right-hand side of the machine to indicate the detergent solution tap control lever.

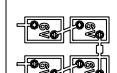

**Battery connection symbol (6V):**



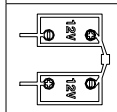











Located on the front of the solution tank, to indicate how to connect the 6V batteries in order to obtain a total voltage of 24V.



**Battery connection symbol (12V):**

Located on the front of the solution tank, to indicate how to connect the 12V batteries in order to obtain a total voltage of 24V.

## LABELS USED ON THE MACHINE

	<p><b>Main switch symbol:</b> Used by the control handlebars to indicate the main switch on the machine.</p>
	<p><b>Label for detergent solution tap command:</b> Used on the rear right-hand side of the machine to identify the detergent solution tap control lever.</p>
	<p><b>Label indicating the need to read the Use and Maintenance Manual:</b> Used above the recovery tank, near the control handlebar, to indicate to the operator that he/she must read the use and maintenance manual before using the machine.</p>
	<p><b>Battery recharge warning label:</b> This is located inside the machine above the recovery tank, near the batteries, to indicate to the operator that he/she must pay attention when performing the battery recharge cycle.</p>
	<p><b>Battery charging sequence label (versions without Battery Charger):</b> This is located inside the machine above the recovery tank, near the batteries, to indicate to the operator the sequence to be followed in order to charge the batteries correctly.</p>
	<p><b>Battery charging sequence label (versions with battery charger):</b> This is located inside the machine above the recovery tank, near the batteries, to indicate to the operator the sequence to be followed in order to charge the batteries correctly.</p>
	<p><b>Machine use warning label:</b> Used on the rear of the machine, near the main switch, to indicate to the operator that vacuuming/collecting flammable and/or explosive powders and/or liquids or incandescent particles is strictly prohibited.</p>
	<p><b>Water system filter maintenance label:</b> Use on the rear right-hand side of the machine to indicate to the operator that the water system filter must be cleaned after each work cycle.</p>
	<p><b>Label warning about the risk of crushed hands:</b> Used inside the machine above the solution tank, near the recovery tank lifting handle, to indicate to the operator that there is a risk of injury to hands due to crushing between two surfaces.</p>
	<p><b>Label indicating the need to read the Use and Maintenance Manual:</b> Used at the rear of the machine, near the squeegee control lever, to indicate to the operator that he/she must read the use and maintenance manual before using the machine.</p>
	<p><b>Battery charging position label:</b> Used inside the machine above the solution tank, near the recovery tank rotation stop lever, to indicate to the operator how the recovery tank should be positioned when recharging the batteries.</p>
	<p><b>Maintenance position label:</b> Used inside the machine above the solution tank, near the recovery tank rotation stop lever, to indicate to the operator how the recovery tank should be positioned when carrying out maintenance on the components located inside the battery compartment.</p>
	<p><b>Detergent solution automatic dosing system warning label (versions with CDS):</b> Used inside the machine above the recovery tank, near the detergent tank, to indicate to the operator which type of pH detergent can be used with the CDS system without damaging it.</p>
	<p><b>Detergent dilution label (versions with CDS):</b> Used inside the machine above the recovery tank, near the detergent tank, to indicate to the operator the capacity of the detergent tank and the dilution percentage for the CDS system.</p>
	<p><b>Detergent solution automatic dosing system warning label (versions with CDS):</b> Used above the detergent tank to indicate to the operator which type of pH detergent can be used with the CDS system without damaging it.</p>

## SYMBOLS USED ON THE CONTROL PANEL

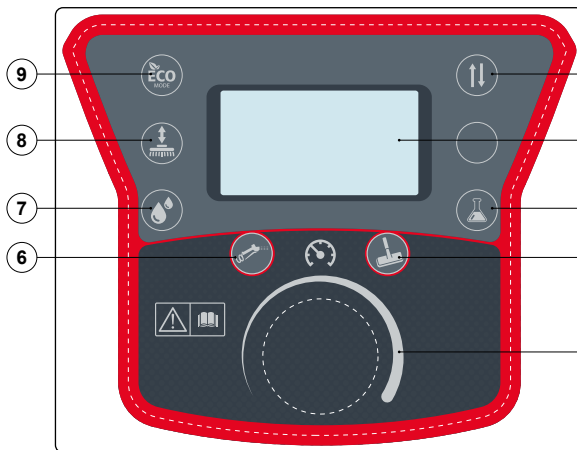

The control screen is divided as follows:

1. Symbol of the reverse movement selector: indicates the switch that enables reverse gear to be activated.
2. Command display: this is a digital display that enables the parameters set on the machine to be viewed during use.
3. Detergent percentage adjustment symbol (versions with CDS system): indicates the switch that enables the percentage of detergent inside the water circuit to be adjusted.
4. Liquid vacuum wand activation symbol (SST versions): indicates the switch that enables the liquid vacuum wand function to be activated (see "LIQUID VACUUM WAND FUNCTION").
5. Traction motor potentiometer symbol: indicates the knob that enables the potentiometer associated with the traction motor to be adjusted.
6. Tank cleaning gun activation symbol (SST versions): indicates the switch that enables the tank cleaning gun function to be activated (see "TANK CLEANING GUN FUNCTION").
7. Water level adjustment symbol (versions with CDS system): indicates the switch that enables the percentage of water inside the water circuit to be

adjusted.

8. Brush head control symbol (versions with PM system): indicates the button that controls the jack used for lifting the brush head.
9. Symbol for ECO-MODE program: indicates the switch that enables ECO-MODE to be activated.

## SYMBOLS USED ON THE CONTROL PANEL

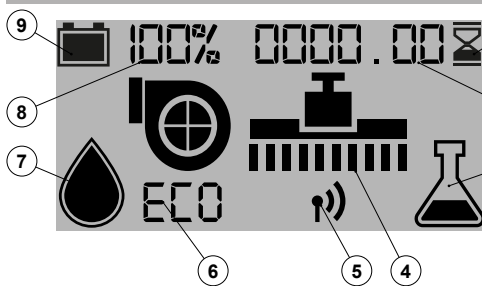

The control screen is divided as follows:

1. Graphic symbol that identifies the machine's hour meter (see "MACHINE HOUR METER").
2. Numerical value that indicates the machine's total working time; this value is expressed in hours and minutes (see "MACHINE HOUR METER").
3. Graphic symbol that identifies the percentage of detergent present in the machine's water system (see "ADJUSTMENT OF THE DETERGENT SOLUTION").
4. Graphic symbol that identifies the type of working programme in use (see "WORKING").
5. Graphic symbol that indicates that the CFC system is active.
6. Graphic symbol that indicates that the ECO-MODE work mode is active (see "ECO-MODE").

7. Graphic symbol which identifies the quantity of water present in the machine's water system (see "ADJUSTMENT OF THE DETERGENT SOLUTION").
8. Numerical value that identifies the percentage of charge of the batteries in the machine (see "BATTERY CHARGE LEVEL").
9. Graphic symbol that identifies the percentage of charge of the batteries in the machine (see "BATTERY CHARGE LEVEL").

## PREPARATION OF MACHINE

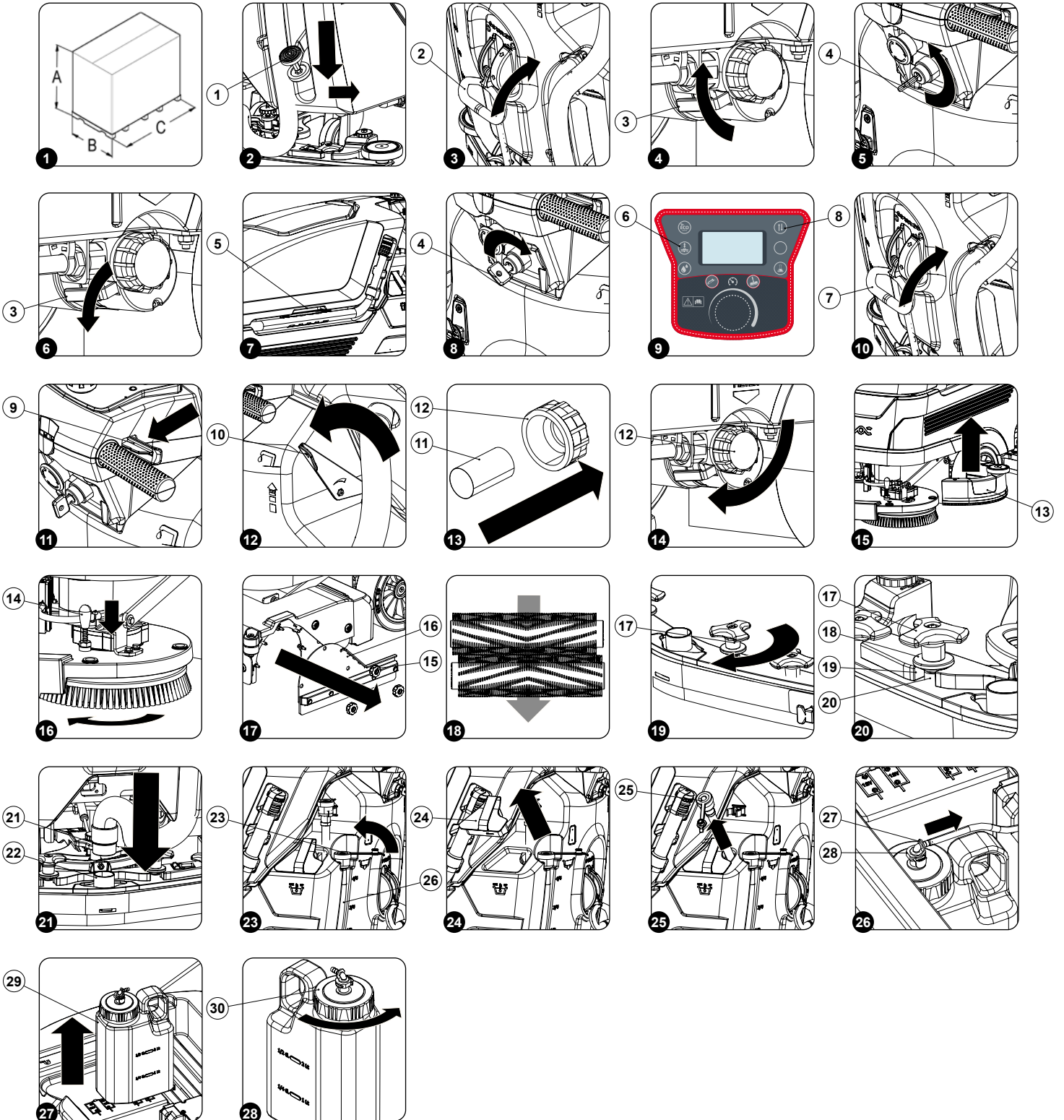

## HANDLING THE PACKAGED MACHINE

Gross weight of machine with packaging is: Vega 2019 65 Bt= 000kg; Vega 2019 75 Bt= 000kg; Vega 2019 85 Bt= 000kg; Vega 2019 70 Bto= 000kg; Vega 2019 70 Bts= 000kg.

The overall dimensions of the package are: A=000cm B=000cm C=000cm

 **ATTENTION:** It is recommended that all the packaging components be kept for any future machine transportation.

 **ATTENTION:** Move the packaged product with handling equipment that complies with legal requirements regarding the size and mass of the packaging.

## HOW TO UNPACK THE MACHINE (versions without PM)

The machine is shipped in specific packaging. To remove it, proceed as follows:

1. Place the lower part of the outer packaging in contact with the floor.

 **N.B.:** Use the pictograms printed on the box as reference.

2. Remove the outer package.

 **CAUTION:** It is recommended that you wear the PPE (Personal Protective Equipment) suited to the work to be carried out.

3. Raise the brush head body and press the brush head control pedal (1) (on the rear of the machine) downwards (**Fig.2**).

4. Raise the squeegee body and turn the squeegee control lever (2) in the direction of the arrow present in (**Fig.3**); the lever is located on the back of the machine.

5. The machine is fixed to the pallet by means of chocks, which block the wheels and brush head; remove these chocks.

6. Go to the rear right-hand side of the machine and deactivate the electric brake, turn the lever (3) in the direction of the arrow (**Fig.4**).

7. Use a ramp to bring the machine down from the pallet.

 **N.B.:** do not fit the brush and the rear squeegee body before unloading the machine, and avoid any violent jolts to the brush head and squeegee support.

 **N.B.:** during the operation to move it by pushing, the electric brake should not be engaged. In any case, the device will be equipped with safety braking; once a set critical speed has been exceeded, the internal braking system will activate automatically.

## HOW TO UNPACK THE MACHINE (versions with PM)

The machine is shipped in specific packaging. To remove it, proceed as follows:

1. Place the lower part of the outer packaging in contact with the floor.

 **N.B.:** Use the pictograms printed on the box as reference.

2. Remove the outer package.

 **CAUTION:** It is recommended that you wear the PPE (Personal Protective Equipment) suited to the work to be carried out.

3. Check that the machine is off, otherwise set the main switch (4) to position "0" by turning the key a quarter turn to the left (**Fig. 5**). Remove the key from the instrument panel.

4. Go to the rear right-hand side of the machine and activate the electric brake, turn the lever (3) in the direction of the arrow (**Fig.6**).

5. Grip the handle (5) on the left-hand side of the recovery tank (**Fig.7**) and turn the tank as far as it will go.

6. Connect the battery hopper connector to the connector on the general system.

 **WARNING:** This process must be carried out by qualified personnel.

7. Grip the handle (5) on the left-hand side of the recovery tank and turn the tank until it reaches the work position.

8. The machine is fixed to the pallet by means of chocks, which block the wheels and brush head; remove these chocks.

9. Turn on the machine, move the main switch to position "I" (4), turning the key a quarter turn to the right (**Fig.8**).

10. Lift the brush head body, press the "BRUSH HEAD COMMAND" button (6) on the control panel (**Fig.9**).

11. Switch off the machine by moving the main switch (4) to position "0", turning the key a quarter turn to the left (**Fig.5**). Remove the key from the instrument panel.

12. Raise the squeegee body and turn the squeegee control lever (7) in the direction of the arrow present in (**Fig.10**); the lever is located on the back of the machine.

13. Go to the rear right-hand side of the machine and deactivate the electric brake, turn the lever (3) in the direction of the arrow (**Fig.4**).

14. Use a ramp to bring the machine down from the pallet.

 **N.B.:** do not fit the brush and the rear squeegee body before unloading the machine, and avoid any violent jolts to the brush head and squeegee support. during the operation to move it by pushing, the electric brake should not be engaged. In any case, the device will be equipped with safety braking; once a set critical speed has been exceeded, the internal braking system will activate automatically.

## HOW TO MOVE THE MACHINE

To transport the machine safely, proceed as follows:

1. Check to make sure that the solution tank and the recovery tank are empty. If this is not the case, empty them (see the sections titled "[EMPTYING THE SOLUTION TANK](#)" and "[EMPTYING THE RECOVERY TANK](#)").
2. Insert the key (4) into the main switch on the control panel. Set the main switch to "I" (**Fig.8**).
3. Raise the brush head body and for versions without PM, depress the "BRUSH HEAD BODY CONTROL" pedal (1) at the rear of the machine fully (**Fig.2**). For versions with PM, lift the brush head body by pressing the "BRUSH HEAD CONTROL" button (6) on the control panel (**Fig.9**).
4. Raise the squeegee body and turn the squeegee control lever (7) clockwise (**Fig.10**).
5. When you push the dead man's lever (9) (**Fig.11**), the machine will begin to move.
6. Use a ramp to move the machine up onto the transport vehicle.

 **CAUTION:** During this operation, check there are no people or objects near the machine.

 **N.B.:** the ramp gradient must not be such as to cause damage to the machine as it goes up.

7. Position the machine on the means of transport, and set the main switch to the "0" position by turning the key (4) a quarter turn anti-clockwise.
8. Grip the handle (5) on the left-hand side of the recovery tank (**Fig.7**) and turn the tank as far as it will go.
9. Disconnect the electrical connector from the general system.

 **WARNING:** This process must be carried out by qualified personnel.

10. Grip the handle (5) on the left-hand side of the recovery tank and turn the tank until it reaches the work position.
11. Fix the machine to the means of transport being used.

 **WARNING:** secure the device according to the directives in force in the country of use, so that it cannot slide or tip over.

## MACHINE SAFETY

To ensure that work is carried out in the best safety conditions, proceed as follows:

1. Make sure the solution tank is empty. If this is not the case, empty it (read "[EMPTYING THE SOLUTION TANK](#)").
2. Make sure the recovery tank is empty. If this is not the case, empty it (read "[EMPTYING THE RECOVERY TANK](#)").
3. Insert the key (4) into the main switch on the control panel. Set the main switch to "I" (**Fig.8**).
4. Raise the brush head body and for versions without PM, depress the "BRUSH HEAD BODY CONTROL" pedal (1) at the rear of the machine fully (**Fig.2**). For versions with PM, lift the brush head body by pressing the "BRUSH HEAD CONTROL" button (6) on the control panel (**Fig.9**).

 **N.B.:** to lock the brush head in the raised position, depress the pedal (1) fully and then move it towards the right-hand side of the machine (**Fig.2**).

5. Raise the squeegee body and turn the squeegee control lever (7) clockwise (**Fig.10**).
6. Bring the main switch to position "0" by turning the key (4) a quarter turn anti-clockwise (**Fig.5**). Remove the key from the instrument panel.
7. Grip the handle (5) on the left-hand side of the recovery tank (**Fig.7**) and turn the tank as far as it will go.
8. Disconnect the electrical connector from the general system.

 **WARNING:** This process must be carried out by qualified personnel.

9. Grip the handle (5) on the left-hand side of the recovery tank and turn the tank until it reaches the work position.

## TYPE OF BATTERY TO BE USED

Power to the machine must be supplied by four sealed traction batteries with gas recombination or gel technology. The batteries must meet the requirements laid out in the norms: CEI EN 60254-1:2005-12 (CEI 21-5) + CEI EN 60254-2:2008-06 (CEI 21-7). In order to ensure good operating performance, it is recommended to use four 6V MFP 180 Ah/C5 batteries.

## INSERTING THE BATTERIES IN THE MACHINE

To fit the batteries inside the machine, contact an COMAC assistance centre technician.

 **WARNING:** COMAC declines all responsibility for any damage to property or injury persons in the event that the batteries are replaced by an unauthorized technician.

## BATTERY MAINTENANCE AND DISPOSAL

For battery maintenance and recharging, respect the instructions provided by the battery manufacturer.



When the batteries reach the end of their service life, they must be disconnected by a COMAC assistance centre technician or by a specialised and properly trained worker, and must be subsequently removed from the battery compartment using suitable lifting devices.



**N.B.:** dead batteries are classified as dangerous waste and as such must be delivered to an authorised body for disposal.

## RECHARGING THE BATTERIES

The batteries must be charged prior to first use, and whenever they no longer provide sufficient power to perform the desired work.

-  **CAUTION:** The control board and the battery charger, if present on board, can be set for gel or lead-acid batteries; contact your nearest COMAC assistance centre to modify the correct setting of the machine.
-  **CAUTION:** to avoid any permanent damage to the batteries, it is essential to avoid their complete discharge; begin recharging them within a few minutes of noting the "discharged batteries" signal.
-  **CAUTION:** Never leave the batteries completely discharged, even if the machine is not being used.

1. Bring the machine to the battery recharging area.

-  **CAUTION:** Park the machine in an enclosed place, on a flat and level surface; near the machine there must be no objects that could either damage it, or be damaged through contact with it.

-  **DANGER:** the room used to recharge the batteries must be adequately ventilated to prevent the accumulation of gases that leak from batteries.

2. Perform the procedure for securing the machine ( see the section titled "[SECURING THE MACHINE](#)").
3. Grip the handle (5) on the left-hand side of the recovery tank (**Fig.7**) and turn the tank as far as it will go.

To recharge the batteries without the built-in battery charger, proceed as follows:

-  **CAUTION:** the following operations must be carried out by qualified personnel. An incorrect connection of the connector may cause problems with machine functioning.
- Disconnect the electric system connector from the battery connector.
- Connect the external battery charger cable to the battery connector.
- Grip the handle (5) on the left-hand side of the recovery tank (**Fig.7**) and turn the recovery tank until it reaches the battery charging position.

-  **N.B.:** the coupling connector of the battery charger is consigned inside the bag containing this instruction booklet, and must be assembled on the cables of the battery charger as indicated in the instructions.

-  **DANGER:** before connecting the batteries to the battery charger, make sure it is suitable for the batteries used.

-  **N.B.:** carefully read the use and maintenance instructions of the battery charger that is used for charging.

-  **CAUTION:** keep the recovery tank open for the duration of the battery recharging cycle to allow gas fumes to escape.

- Once the recharge cycle has been completed, rotate the recovery tank to the maintenance position and disconnect the battery charger's cable from the battery connector.
- Connect the electrical system connector to the battery connector.
- Grip the handle (5) on the left-hand side of the recovery tank (**Fig.7**) and turn the recovery tank until it reaches the work position.

To recharge the batteries with the on-board battery charger proceed as follows:

-  **CAUTION:** the following operations must be carried out by qualified personnel. An incorrect connection of the connector may cause problems with machine functioning.

-  **N.B.:** Carefully read the use and maintenance instructions of the battery charger that is used for charging, this document is delivered along with the machine.

-  **CAUTION:** before connecting the batteries to the battery charger, make sure it is suitable for the batteries used.

-  **N.B.:** The charger power cable is delivered inside the bag containing this instruction booklet.

- Plug the battery charger cable into the mains socket.
- Connect the battery charger's power cable to the socket on the battery charger itself.
- Grip the handle (5) on the left-hand side of the recovery tank (**Fig.7**) and turn the recovery tank until it reaches the battery charging position.



**CAUTION:** keep the recovery tank open for the duration of the battery recharging cycle to allow gas fumes to escape.

- Once the recharge cycle has been completed, rotate the recovery tank to the maintenance position and disconnect the battery charger's cable from the battery connector.
- Connect the electrical system connector to the battery connector.
- Grip the handle (5) on the left-hand side of the recovery tank (**Fig.7**) and turn the recovery tank until it reaches the work position.

## INSERTING WATER SYSTEM FILTER

Before using the machine for the first time the water system filter needs to be reset, for shipping reasons the filter cartridge and the cap have been removed. To insert the filter cartridge in the water system filter body proceed as follows:

1. Take the machine to the maintenance area.
2. Make sure the machine has been secured (see the section titled "[SECURING THE MACHINE](#)").



**CAUTION:** It is recommended that you wear the PPE (Personal Protective Equipment) suited to the work to be carried out.

3. Tighten the outlet flow of the tap, turn the lever (10) on the back of the machine anti-clockwise (**Fig.12**).
4. Move to the right-hand side of the machine, insert the filter cartridge (11) in the housing on the cap (12) (**Fig.13**).



**N.B.:** The O-ring gasket in the filter cartridge should be inserted into its seat in the cap.

5. Screw the cap (12) onto the body of the detergent solution filter (**Fig.14**).

## ASSEMBLING THE BRUSH (SCRUBBING VERSION)

To assemble the brushes to brush head body, which for reasons of packaging are supplied dismantled from the machine, proceed as follows:

1. Perform the procedure for securing the machine ( see the section titled "[SECURING THE MACHINE](#)").



**CAUTION:** It is recommended that you wear the PPE (Personal Protective Equipment) suited to the work to be carried out.

2. With the brush head in the raised position, remove the brush head splash guards (13) (**Fig.15**).
3. Insert the brush into the flange on the brush head body, press the brush-holder plate retainer (14) and simultaneously rotate the brush in the direction shown in the image (**Fig.16**).



**ATTENTION:** **Fig.16** shows the rotation direction of the left-hand brush, rotate in the opposite direction for the right-hand brush.

4. Repeat the operations completed for the right-hand front brush as well.

## ASSEMBLING THE BRUSH (SWEEPING VERSION)

To assemble the brushes to brush head body, which for reasons of packaging are supplied dismantled from the machine, proceed as follows:

1. Perform the procedure for securing the machine ( see the section titled "[SECURING THE MACHINE](#)").



**CAUTION:** It is recommended that you wear the PPE (Personal Protective Equipment) suited to the work to be carried out.

2. With the brush head raised from the floor, turn the knobs (15) that hold the left lateral carter (16) in place anti-clockwise (**Fig.17**). Remove the left-hand side carter.
3. Insert the brush into the tunnel, taking care to make sure that the gearmotor's drive shaft enters the slit in the brush itself.
4. Repeat the previously described operations for the right-hand side as well.



**N.B.:** In order to be installed correctly, the brushes must form an X when viewed from above in the forward direction of movement (**Fig.18**).

## ASSEMBLING THE ABRASIVE PAD (ORBITAL VERSION)

For packaging reasons, the abrasive pad comes disassembled from the machine. To assemble it on the brush head body, proceed as follows:

1. Perform the procedure for securing the machine ( see the section titled "[SECURING THE MACHINE](#)").



**CAUTION:** It is recommended that you wear the PPE (Personal Protective Equipment) suited to the work to be carried out.

2. With the brush head raised above the floor, insert the abrasive pad under the brush head body.



## ASSEMBLING THE SQUEEGEE BODY

For packaging reasons, the squeegee body comes disassembled from the machine. In order to mount it on the squeegee support, do the following:

1. Make sure the machine is in a safe condition (read "["MACHINE SAFETY"](#)").
2. Raise the squeegee body and turn the squeegee control lever (7) in the direction of the arrow (**Fig.10**); the lever is located on the back of the machine.

 **CAUTION:** It is recommended that you wear the PPE (Personal Protective Equipment) suited to the work to be carried out.

3. Unscrew the knobs (17) in the squeegee body pre-assembly (**Fig.19**).
4. First of all, insert the left-hand pin (18) on the squeegee body in the left slit (19) in the squeegee support (**Fig.20**), so that the bushing (20) adheres to the walls of the slit in the squeegee support.
5. Tighten the knobs (17) to fix the squeegee body to the support.
6. Repeat the same operation for the right pin.
7. Insert the vacuum tube (21) in the sleeve (22) in the squeegee body (**Fig.21**).

 **N.B.:** the tube must be positioned behind the squeegee lifting chain.

 **N.B.:** Although the squeegee comes pre-adjusted, it is nevertheless recommended to read the section titled "ADJUSTING THE SQUEEGEE BODY'S RUBBER BLADES".

## FILLING THE SOLUTION TANK WITH WATER

Before filling the solution tank, carry out the following steps:

1. Take the machine to the usual place for filling the solution tank.
2. Perform the procedure for securing the machine ( see the section titled "["SECURING THE MACHINE"](#)").
3. Check that the solution tank discharge cap (12) is open. If it isn't, open it (**Fig.14**).
4. Check the water system filter cap (23) (on the right-hand side of the machine) is tight. If this is not the case, turn it clockwise (**Fig.23**).

The solution tank can be filled with water in three different ways:

- Removing the cap/measuring device (24) and filling the solution tank by means of a rubber hose or a bucket (**Fig.24**).
- Using the filler hose (25) (**Fig. 25**), which supports the water hose on its own.
- Using the optional system for automatic clean water top-up. This system has a float for avoiding any overflow.
- Fill with clean water, at a temperature not higher than 50°C and not lower than 10°C. You can check the quantity in the tank by means of the level tube (26) (**Fig. 23**).

## DETERGENT SOLUTION

For the versions without automatic detergent dosing system, after filling the solution tank with clean water, add the liquid detergent to the tank in the concentration and manner indicated on the detergent manufacturer's label.

To prevent the formation of an excessive amount of foam that could damage the vacuum motor, use the minimum percentage of detergent required.

 **CAUTION:** It is recommended that you wear the PPE (Personal Protective Equipment) suited to the work to be carried out.

 **ATTENTION:** Always use detergents whose manufacturer's label indicates their suitability for scrubbing machines. Do not use acid or alkaline products or solvents without this indication.

 **ATTENTION:** always use low-foam detergent. To avoid the production of foam, put a minimum quantity of antifoam liquid in the recovery tank before starting to clean. Do not use pure acids.

 **N.B.:** to make it easier to measure the detergent on the cap/measuring device, there are two notches indicating the two main detergent percentage quantities that can be used.

For versions with automatic detergent dosing system, fill the solution tank with clean water and then proceed as follows:

1. Grip the handle (5) on the left-hand side of the recovery tank (**Fig.7**) and turn the tank as far as it will go.
2. Disconnect the male insert (27) from the female insert (28) on the cap of the detergent canister (**Fig.26**).

 **N.B.:** before pulling on the male insert, push the lever in the female insert.

3. Grip the handle on the detergent canister (29) to remove it from the compartment in the solution tank (**Fig.27**).
4. Unscrew the cap (30) of the detergent canister (**Fig.28**).
5. Fill the canister with the required detergent, as indicated on the label of the machine.

 **CAUTION:** It is recommended that you wear the PPE (Personal Protective Equipment) suited to the work to be carried out.

- i** **N.B.:** always use low-foam detergent. To avoid the production of foam, put a minimum quantity of antifoam liquid in the recovery tank before starting to clean. Do not use pure acids.
  - ⚠** **ATTENTION:** always use detergents whose manufacturer's label indicates their suitability for scrubbing machines. Do not use acid or alkaline products or solvents without this indication.
  - ⚠** **ATTENTION:** the dosing system is suitable for frequent maintenance cleaning. Acid or alkaline maintenance detergent can be used with pH values between 4 and 10 and that do not contain: oxidising agents, chlorine or bromine, formaldehyde, mineral solvents. The detergents used must be suitable for use with scrubbing machines. Wash the circuit with water after use if the system is not used daily. The system can be excluded. In case of sporadic use of detergents with pH between 1-3 or 11-14, use the floor scrubbing machine in the traditional way by adding the detergent in the clean water tank and excluding the dosing circuit.
6. Tighten the screw cap (18) properly to prevent liquid leakage during operation, and ensure that the detergent suction filter (19) is correctly positioned at the bottom of the canister.
  7. Grip the canister handle to replace the canister in its compartment inside the solution tank.
  8. Connect the male insert to the female insert in the cap of the detergent canister.
  9. Grip the handle (5) on the left-hand side of the recovery tank and turn the recovery tank until it reaches the work position.

## PREPARING TO WORK

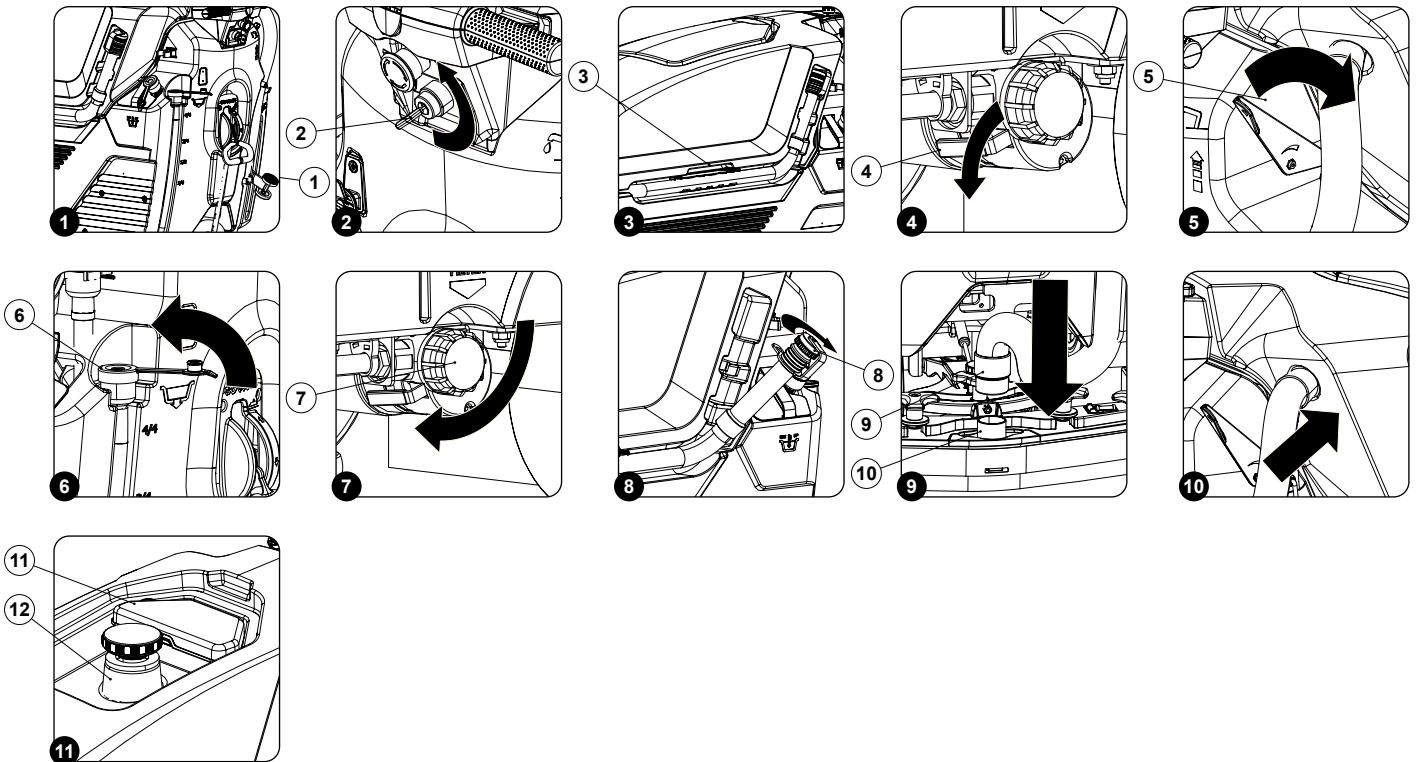

Before beginning to work, it is necessary to:

1. Make sure the recovery tank is empty. If this is not the case, empty it (read "[EMPTYING THE RECOVERY TANK](#)").
2. Check that the amount of detergent solution in the solution tank is sufficient for the type of work to be performed. If it isn't, top up the solution tank (see "[FILLING THE SOLUTION TANK WITH WATER](#)" and "[DETERGENT SOLUTION](#)"). Check the level tube (1) in the rear left-hand part of the machine (**Fig.1**).
3. Check the rubber squeegee blades are in good working condition. If they aren't, replace them (see "[REPLACING THE SQUEEGEE BODY RUBBER BLADES](#)").
4. Check that the condition of the brush is suitable for work; if this is not the case, replace it (see "[REPLACING THE BRUSH HEAD BRUSH \(SCRUBBING VERSION\)](#)" or "[REPLACING THE BRUSH HEAD BRUSH \(SWEEPING VERSION\)](#)").
5. Check that the machine is off; if this is not the case, turn the key (2) a quarter turn anti-clockwise (**Fig.2**) . Remove the key from the instrument panel.
6. Grip the handle (3) on the right-hand side of the recovery tank (**Fig.3**) and turn the tank as far as it will go, until it reaches the maintenance position.
7. Connect the general system connector to the battery connector.

**⚠** **ATTENTION:** This process must be carried out by qualified personnel.

8. Grip the handle (3) on the right-hand side of the recovery tank and turn the tank until it reaches the work position.
9. Make sure the electronic brake is engaged. If it isn't, turn the lever (4) in the direction of the arrow. The traction gearmotor is located on the rear right-hand side of the machine (Fig.4).
10. Check the water tap is fully open; turn the tap control lever (5) clockwise (Fig.5).
11. Check to make sure that the solution tank drainage cap (6) is closed. If this is not the case, close it (Fig.6).
12. Make sure the water system filter cap (7) is closed. If it isn't, close it (Fig.7).
13. Make sure the cap of the recovery tank drainage tube (8) is closed. If it isn't, close it (Fig.8).
14. Make sure the vacuum tube (9) is correctly connected to the sleeve (10) in the squeegee body. If it isn't, connect it (Fig.9).
15. Make sure the vacuum tube (9) is correctly inserted into the hole on the recovery tank. If it isn't, connect it (Fig.10).
16. Make sure the filter basin (11) is correctly connected and is clean (Fig.11). If it isn't, clean it (see "CLEANING THE RECOVERY TANK FILTERS").
17. Make sure the overfill float (12) is working correctly (Fig.11). If it isn't, clean it (see "CLEANING THE RECOVERY TANK FILTERS").

## STARTING WORK

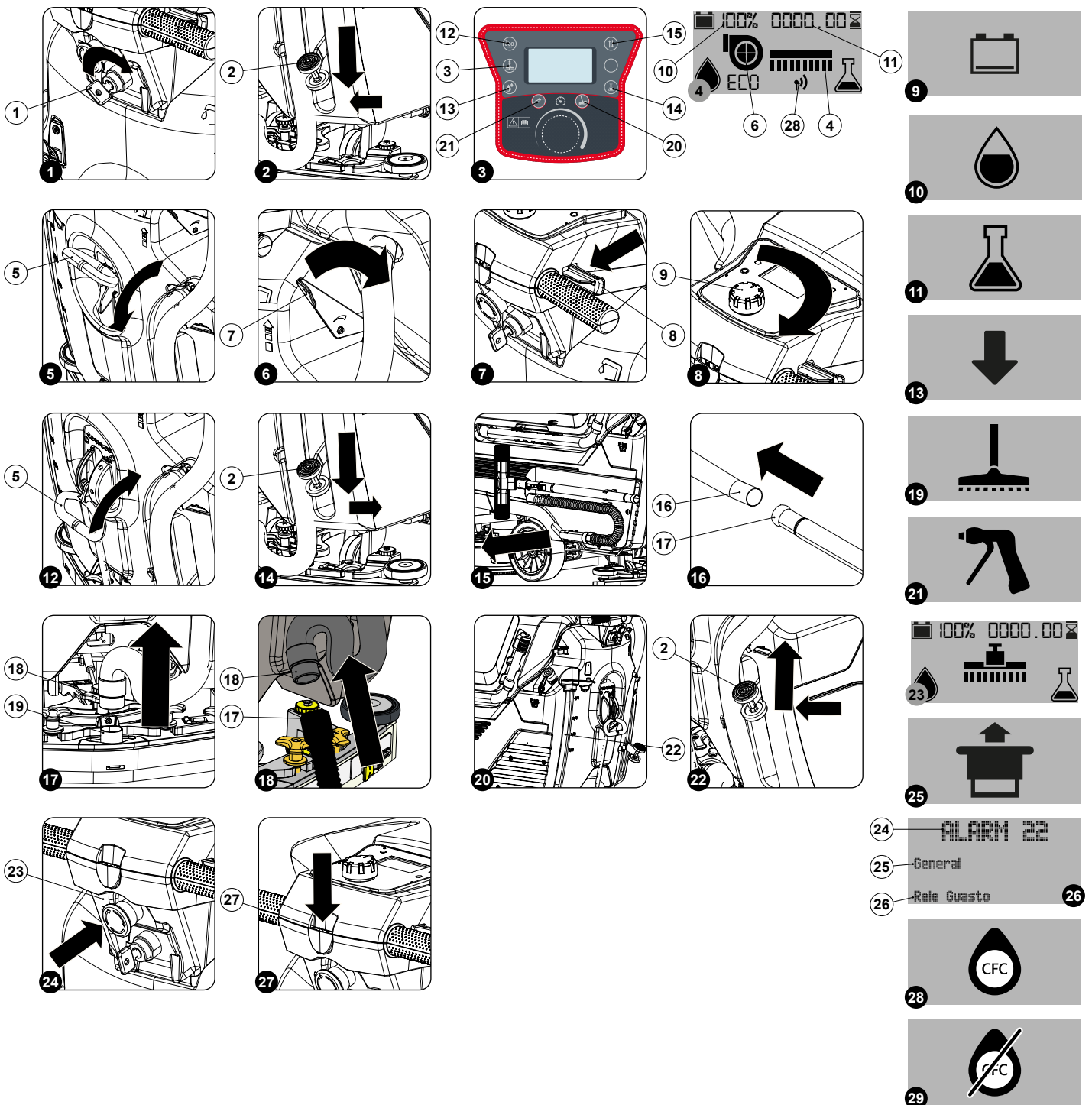



To start working, do as follows:

1. Carry out all the checks in the paragraph [“STARTING WORK”](#).
2. Turn on the machine and move the main switch to position "I" by turning the key (1) a quarter turn clockwise (**Fig.1**).
3. When the display comes on, three screens appear in sequence:
  - The first screen displayed indicates the logo of the manufacturer of the machine.
  - The second screen displayed indicates the name of the machine.
  - The third screen displayed indicates the characteristics of the machine's programming.
4. For versions without the PM function, lower the brush head body using the brush head body control pedal (2); the pedal is positioned at the rear of the machine (**Fig.2**).
5. For versions with the PM function, lower the brush head body, pressing the “BRUSH HEAD COMMAND” button (3) on the control panel (**Fig.3**).

 **N.B.:** As soon as the brush head body is removed from the rest position, the control display shows the symbol (4) (**Fig.4**).

6. Lower the squeegee body using the squeegee control lever (5); the lever is located on the back of the machine (**Fig.5**).

 **N.B.:** As soon as the squeegee body is removed from the rest position, the control display shows the symbol (6) (**Fig.4**).

 **N.B.:** When both symbols (4) and (6) appear on the control display, it means that the “SCRUBBING WITH DRYING” function is being performed (**Fig.4**).

7. Turn the tap control lever (7) clockwise; the lever is located on the right-hand side of the machine (**Fig.6**).

 **N.B.:** Remember to fully open the detergent solution flow, turning the lever as far as it will go (7).

 **N.B.:** To adjust the flow of detergent solution, see [“ADJUSTING THE DETERGENT SOLUTION \(versions without CDS system\)”](#) or [“ADJUSTING THE DETERGENT SOLUTION \(versions with CDS system\)”](#).

8. Use the dead man's levers (8) on the instrument panel (**Fig.7**).

 **N.B.:** The machine has two forward speeds. By pushing the dead man's levers beyond the first CLICK the “SLOW” speed is activated, continuing to push the levers beyond the second CLICK the “FAST” speed is activated.

9. Set the required forward speed by turning the knob (9) gradually to the right (**Fig.8**).

 **N.B.:** To adjust the forward speed, see [“SPEED ADJUSTMENT”](#).

10. When you push the dead man's lever (8), the machine will begin to move.

 **N.B.:** the gearmotor will only begin functioning, and the solenoid valve will only begin dispensing detergent solution, when the brush head body is in its working position.

11. During the first few meters, check that the detergent solution coming out is appropriate to the work to be carried out; if this is not the case, adjust it.

The machine will now begin to work with full efficiency until the battery is flat or until the detergent solution has finished. During the first few metres, check that there is sufficient solution and that the squeegee is drying correctly.

 **N.B.:** If the dead man's lever is released during the scrubbing with drying operation, the brush motor and the solenoid valve will be deactivated. The suction motor will continue working until the squeegee control lever is rotated to bring it back to its idle position.

 **N.B.:** if the squeegee body is raised during the scrubbing and drying operation, the suction motor will continue working at maximum speed for a certain period of time, and then switch off. This ensures that all the liquid in the vacuum tube is eliminated.

 **N.B.:** when filling the solution tank, it is good practice to empty the recovery tank using the special drainage hose.

## BATTERY CHARGE LEVEL INDICATOR

The control display is located on the machine control panel; in the upper left area, a numerical value (10) can be seen that identifies the percentage of charge of the batteries (**Fig.4**). The graphic symbol adjacent to the numerical value is composed of 5 charge levels, each of which represents about 20% of residual charge. With a residual charge of 20%, the graphic symbol starts to flash. After a few seconds it appears in a larger size in the middle of the screen (**Fig.9**); at this point, you must take the machine to the designated recharging area.

 **N.B.:** a few seconds after the battery charge level reaches 20%, the brush motor switches off automatically. With the remaining charge it is still possible, however, to complete the drying process before recharging

 **N.B.:** a few seconds after the battery charge level reaches 10%, the suction motor switches off automatically. With the remaining charge, it is still possible, however, to move the appliance to the location designated for its recharging.

## HOURLY METER

The machine control panel contains the control display; the upper right-hand area of this shows the total machine usage time (11) (Fig. 4). The figures to the left of the “.” symbol identify the hours, while the figures to the right of the “.” symbol identify the minutes. The flashing hourglass symbol indicates that the hour meter is counting the time the machine is operating.

## SCRUBBING WITH DRYING

To carry out “SCRUBBING AND DRYING” tasks, proceed as follows:

1. Carry out all the checks in the paragraph “[STARTING WORK](#)”.
2. Turn on the machine and move the main switch to position “I” by turning the key (1) a quarter turn clockwise (Fig.1).
3. For versions without the PM function, lower the brush head body using the brush head body control pedal (2); the pedal is positioned at the rear of the machine (Fig.2).
4. For versions with the PM function, lower the brush head body, pressing the “BRUSH HEAD COMMAND” button (3) on the control panel (Fig.3).

**i** **N.B.:** As soon as the brush head body is removed from the rest position, the control display shows the symbol (4) (Fig.4).

5. Lower the squeegee body using the squeegee control lever (5); the lever is located on the back of the machine (Fig.5).

**i** **N.B.:** As soon as the squeegee body is removed from the rest position, the control display shows the symbol (6) (Fig.4).

**i** **N.B.:** When both symbols (4) and (6) appear on the control display, it means that the “SCRUBBING WITH DRYING” function is being performed (Fig.4).

6. Turn the tap control lever (7) clockwise; the lever is located on the right-hand side of the machine (Fig.6).

**i** **N.B.:** Remember to fully open the detergent solution flow, turning the lever as far as it will go (7).

**i** **N.B.:** To adjust the flow of detergent solution, see “[ADJUSTING THE DETERGENT SOLUTION \(versions without CDS system\)](#)” or “[ADJUSTING THE DETERGENT SOLUTION \(versions with CDS system\)](#)”.

7. Use the dead man's levers (8) on the instrument panel (Fig.7).

**i** **N.B.:** The machine has two forward speeds. By pushing the dead man's levers beyond the first CLICK the “SLOW” speed is activated, continuing to push the levers beyond the second CLICK the “FAST” speed is activated.

8. Set the required forward speed by turning the knob (9) gradually to the right (Fig.8).

**i** **N.B.:** To adjust the forward speed, see “[SPEED ADJUSTMENT](#)”.

As soon as the dead man's levers are pressed the traction motor, brush head motor and vacuum motor will start working. As a result, the solenoid valve will also begin working and detergent solution will be delivered to the brush.

During the first few metres, check that there is sufficient solution and that the squeegee is drying correctly.

The machine will now begin to work with full efficiency until the battery is flat or until the detergent solution has finished.

**i** **N.B.:** If the dead man's levers are released during the work, the machine will stop moving forward, the brush motor and the solenoid valve will stop working; the vacuum motor will keep working for a set period of time and the symbol (4) will start flashing until the vacuum motor switches off.

**i** **N.B.:** If the appliance is switched off with the brush head and the squeegee body still in contact with the floor; when it is switched on again, the work display will show the symbols (4) and (6), indicating that when it was switched off it was performing a scrubbing with drying operation (Fig.4).

**i** **N.B.:** If you need to exert more pressure on the brushes during work, see “[EXTRA BRUSH HEAD PRESSURE](#)”.





## SCRUBBING WITHOUT DRYING

To carry out “SCRUBBING WITHOUT DRYING” tasks, proceed as follows:

1. Carry out all the checks in the paragraph “[STARTING WORK](#)”.
2. Turn on the machine and move the main switch to position “I” by turning the key (1) a quarter turn clockwise (Fig.1).
3. For versions without the PM function, lower the brush head body using the brush head body control pedal (2); the pedal is positioned at the rear of the machine (Fig.2).
4. For versions with the PM function, lower the brush head body, pressing the “BRUSH HEAD COMMAND” button (3) on the control panel (Fig.3).

**i** **N.B.:** As soon as the brush head body is removed from the rest position, the control display shows the symbol (4) (Fig.4).



5. Turn the tap control lever (7) clockwise; the lever is located on the right-hand side of the machine (Fig.6).

-  **N.B.:** Remember to fully open the detergent solution flow, turning the lever as far as it will go (7).
  -  **N.B.:** To adjust the flow of detergent solution, see “[ADJUSTING THE DETERGENT SOLUTION \(versions without CDS system\)](#)” or “[ADJUSTING THE DETERGENT SOLUTION \(versions with CDS system\)](#)”.
6. Use the dead man's levers (8) on the instrument panel (**Fig.7**).
-  **N.B.:** The machine has two forward speeds. By pushing the dead man's levers beyond the first CLICK the “SLOW” speed is activated, continuing to push the levers beyond the second CLICK the “FAST” speed is activated.
7. Set the required forward speed by turning the knob (9) gradually to the right (**Fig.8**).
-  **N.B.:** To adjust the forward speed, see “[SPEED ADJUSTMENT](#)”.

As soon as the dead man's levers are pressed the traction motor, brush head motor and vacuum motor will start working. As a result, the solenoid valve will also begin working and detergent solution will be delivered to the brush.

During the first few metres, check that there is sufficient solution and that the squeegee is drying correctly.

The machine will now begin to work with full efficiency until the battery is flat or until the detergent solution has finished.







-  **N.B.:** If the dead man's levers are released during the work, the machine will stop moving forward and the brush motor and the solenoid valve will stop working.
-  **N.B.:** If the appliance is switched off with the brush head and the squeegee body still in contact with the floor, when switched again, the work display will show the symbol (6), indicating that when it was switched off it was carrying out a scrubbing without drying operation (**Fig.4**).
-  **N.B.:** If you need to exert more pressure on the brushes during work, see “[EXTRA BRUSH HEAD PRESSURE](#)”.

## DRYING

To carry out “DRYING” tasks, proceed as follows:



**The drying without scrubbing operation should only be carried out if the machine was previously used to carry out a scrubbing without drying operation.**

1. Carry out all the checks in the paragraph “[STARTING WORK](#)”.
  2. Turn on the machine and move the main switch to position “I” by turning the key (1) a quarter turn clockwise (**Fig.1**).
  3. Lower the squeegee body using the squeegee control lever (5); the lever is located on the back of the machine (**Fig.5**).
-  **N.B.:** As soon as the squeegee body is removed from the rest position, the control display shows the symbol (6) (**Fig.4**).
  -  **N.B.:** When only the symbol (6) is shown on the control display it means that the work being carried out is a “DRYING” operation (**Fig.4**).
  -  **N.B.:** As soon as the squeegee body is moved from the rest position, the vacuum motor will start to work.
4. Use the dead man's levers (8) on the instrument panel (**Fig.7**).
-  **N.B.:** The machine has two forward speeds. By pushing the dead man's levers beyond the first CLICK the “SLOW” speed is activated, continuing to push the levers beyond the second CLICK the “FAST” speed is activated.
5. Set the required forward speed by turning the knob (9) gradually to the right (**Fig.8**).
-  **N.B.:** To adjust the forward speed, see “[SPEED ADJUSTMENT](#)”.
- The machine will now work at its maximum efficiency level until the batteries run down.
-  **N.B.:** If the dead man's levers are released during the work, the machine will stop moving forward; the vacuum motor will keep working for a set period of time and the symbol (6) will start flashing until the vacuum motor switches off.
  -  **N.B.:** If the appliance is switched off with the brush head and the squeegee body still in contact with the floor, when switched again, the work display will show the symbol (6), indicating that when it was switched off it was carrying out a drying operation (**Fig.4**).

## ECO MODE

This machine has an Eco-Mode function for reducing the noise generated by the vacuum motor, and for reducing the energy used by the machine. To activate or deactivate the Eco-Mode function, proceed as follows.

1. With the machine working, press the button (12) located on the control panel (**Fig.4**).

**i** **N.B.:** When the Eco-Mode function is active, the word "ECO" will be visible on the control display.

2. To disable the Eco-mode function, simply press the button (12).

## ADJUSTING THE DETERGENT SOLUTION (versions without CDS system)

To adjust the amount of detergent solution on the brush, proceed as follows:

1. Open the detergent solution outflow to the maximum; turn the tap control lever clockwise (7) (**Fig.6**).
2. On pushing the dead man's lever (8) (**Fig. 7**), the brush motor will start operating and the solenoid valve will distribute detergent solution to the brush.
3. During the first few meters check that the amount of solution is sufficient to wet the floor, but not so much that it escapes the splash guard; use the lever (7) to adjust the outflow.

## ADJUSTING THE DETERGENT SOLUTION (versions with CDS system)

To regulate the amount of detergent solution on the brushes, proceed as follows:

1. Open the detergent solution outflow to the maximum; turn the tap control lever clockwise (7) (**Fig.6**).

**i** **N.B.:** Before adjusting the solution, make sure that there is detergent in the relevant internal tank.

2. By pressing the "WATER LEVEL ADJUSTMENT" button (13) once (**Fig.3**), you can view the level of water in the machine's water system on the control display.
3. As soon as the button (13) is pressed, the symbol that displays the level of water set will appear in the center of the control display (**Fig.10**).
4. pressing the button (13) again, you can change the level.

**i** **N.B.:** the water level refers to the flow delivered at maximum machine speed. At intermediate speeds, the flow is reduced and is proportional to the value set.

**i** **N.B.:** Eight different levels can be set (from 0 to 7); pressing the button (13) will increase the level by one. Once level 7 has been reached, pressing the button (14) will return to level 0.

**i** **N.B.:** the right water flow should be proportional to the degree of dirt on the floor.

5. By pressing the "DETERGENT LEVEL ADJUSTMENT" button (14) once (**Fig.3**), you can view the level of detergent in the machine's water system on the control display.
6. As soon as the button (14) is pressed, the symbol that displays the level of detergent set will appear in the center of the control display (**Fig.11**).
7. Pressing the button (4) again, you can change the level.

**i** **N.B.:** The detergent quantity level refers to the percentage of chemical product present in the detergent solution in relation to the amount of water selected previously.

**i** **N.B.:** Eight different levels can be set (from 0 to 7); pressing the button (14) will increase the level by one. Once level 7 has been reached, pressing the button (16) will return to level 0.

**i** **N.B.:** The percentage of chemical product in the detergent solution must be proportionate to the amount of dirt present on the floor.

8. By pressing the dead man's levers (8) (**Fig. 7**), both the brush motor and the vacuum motor will start working and the solenoid valve will deliver detergent solution to the brush.
9. During the first few meters check that the amount of solution is sufficient to wet the floor, but not excessive to exit the splash guard.



**⚠** **ATTENTION:** to resolve any malfunctioning of the CDS system, contact the Assistance Centre.

## SPEED ADJUSTMENT

This machine is equipped with electronic traction control. To regulate the potentiometer, proceed as follows:





1. Adjust the forward speed by gradually turning the knob (9) clockwise (**Fig.8**).

**i** **N.B.:** the device will not start to move (either forward or backward) if the potentiometer adjustment knob (9) is set to minimum.

-  **N.B.:** Forward speed can be increased by turning the potentiometer's knob (9) clockwise.
-  **N.B.:** The appliance has two forward speeds. By pushing the dead man's levers (8) (**Fig. 7**) beyond the first CLICK, the "SLOW" speed is activated; by continuing to push the levers beyond the second CLICK, the "FAST" speed is activated.
-  **N.B.:** Adjusting a speed, slow or fast, will imply the automatic modification of the other.







## REVERSE ACTIVATION - DEACTIVATION

To reverse, proceed as follows:

1. Check that the squeegee body is raised off the floor; if this is not the case, adjust the lever (5) on the back of the device (**Fig.12**).
  2. Press the "REVERSE MOVEMENT ACTIVATION - DEACTIVATION" button (15) on the control panel (**Fig.3**).
-  **N.B.:** As soon as the button (15) is pressed, the "BACK" screen will appear on the control display (**Fig.13**).
3. Engage the dead man's levers (8) on the handlebar (**Fig.7**) to start moving the appliance in reverse mode.
-  **N.B.:** The reverse speed is lower than the forward speed to comply with current health and safety standards.
  -  **N.B.:** It is impossible to reverse if the squeegee body touches the floor. In order to reverse, lift the squeegee body from the floor using the relevant lever on the back of the appliance.
  -  **N.B.:** To disable reverse movement, press the button (15) on the control panel again.
  -  **N.B.:** As soon as the button(15) is pressed, the acoustic signal advising that reverse function has been activated will sound.

## VACUUM WAND KIT

On request, the machine can be equipped with the liquid vacuum wand kit; in order to use this, proceed as follows:

1. Insert the key (1) into the main switch on the control panel. Set the main switch to "I" (**Fig.1**).
  2. Raise the brush head body and for versions without PM, depress the "BRUSH HEAD BODY CONTROL" pedal (2) at the rear of the machine fully (**Fig.14**). For versions with PM, lift the brush head body by pressing the "BRUSH HEAD CONTROL" button (3) on the control panel (**Fig.3**).
-  **N.B.:** to lock the brush head in the raised position, depress the pedal (2) fully and then move it towards the right-hand side of the machine (**Fig.14**).
3. Set the main switch to position "0" by turning the key (1) a quarter turn anti-clockwise. Remove the key from the instrument panel.
  4. Lower the squeegee body and turn the squeegee control lever (5) in the direction of the arrow (**Fig.5**). The lever is located on the back of the machine.
  5. Remove all the vacuum kit components from the storage compartment (**Fig.15**).
  6. Connect the wand kit vacuum tube (17) to the extension tube (16) (**Fig.16**).
  7. Remove the squeegee vacuum tube (18) from the sleeve (19) in the squeegee body (**Fig.17**).
  8. Connect the wand kit vacuum tube (17) to the squeegee vacuum tube (18) (**Fig.18**).
  9. Turn on the machine and turn the key (1) a quarter turn clockwise (**Fig.1**).
  10. Activate the vacuum control kit by pressing the button (20) (**Fig.3**).
-  **N.B.:** As soon as the button (20) on the control display is pressed, the symbol for the vacuum wand kit will appear (**Fig.19**).
  -  **N.B.:** With the vacuum wand kit active, the traction and work functions are deactivated.
-  **WARNING:** never pick up solid matter such as dust, cigarette stubs, paper, etc.
  -  **CAUTION:** Never collect gases, explosive/inflammable liquids or powders, nor acids and solvents! These include gasoline, paint thinners and fuel oil (which, when mixed with the vacuum air, can form explosive vapours or mixtures), and also non-diluted acids and solvents, acetones, aluminium and magnesium powders. These substances may also corrode the materials used to construct the machine.
  -  **CAUTION:** If the machine is used in dangerous areas (e.g. petrol stations), the relative safety standards must be observed. It is forbidden to use the machine in environments with a potentially explosive atmosphere.
11. Once the work is complete, disassemble the wand kit and place it in the side support on the machine.





## SPRAY GUN KIT

On request, the machine can be equipped with the spray gun kit. To use this, proceed as follows:

1. Insert the key (1) into the main switch on the control panel. Set the main switch to "I" (Fig.1).
2. Raise the brush head body and for versions without PM, depress the "BRUSH HEAD BODY CONTROL" pedal (2) at the rear of the machine fully (Fig.2). For versions with PM, lift the brush head body by pressing the "BRUSH HEAD CONTROL" button (3) on the control panel (Fig.3).

-  **N.B.:** To lock the brush head in the raised position, depress the pedal (2) fully and then move it towards the right-hand side of the machine (Fig.2).
- 3. Move the squeegee body into the rest position and turn the squeegee body control lever (5) in the direction of the arrow (Fig.12). The lever is located on the back of the machine.
- 4. Release the spray gun accessory (at the back of the machine) from the retainers (Fig.19).
- 5. Activate the optional spray gun kit by pressing the button (21) on the back of the machine (Fig.3).

-  **N.B.:** As soon as the button (21) on the control display is pressed, the symbol for the spray gun kit will appear (Fig.21).

-  **N.B.:** With the spray gun kit active, the traction and work functions are deactivated.

-  **CAUTION:** It is recommended that you wear the PPE (Personal Protective Equipment) suited to the work to be carried out.

-  **N.B.:** Before using the optional tank cleaning kit, check the level indicator (22) to see how much solution there is in the solution tank (Fig.20).

6. Activate the solution jet by pressing the lever in the tank cleaning accessory. Make sure the jet is pointing into the tank before pressing the lever.

## EXTRA BRUSH HEAD PRESSURE

The machine is equipped with a system that allows pressure to be applied on the brushes during work; to activate this function, proceed as follows:

1. For versions without the PM function, lift the brush head control pedal (2) as far as it will go; once you have done this, move it to the left to lock it in place. (Fig.22).
2. For versions with the PM function, press the "BRUSH HEAD CONTROL" button (3) on the control panel for more than 3 seconds (Fig.3).

-  **N.B.:** As soon as the extra pressure function is activated, an icon that looks like a weight will be added to the brush symbol on the control display (Fig.23).

-  **ATTENTION:** Do not use the extra pressure function excessively as this increases the machine's current absorption, thus reducing the battery charge duration.

## EMERGENCY BUTTON

if there are any problems while you are working, press the emergency button (23) under the control handlebars (Fig.24). This function interrupts all functions active at that moment, in this way both the brush head body and the squeegee body will rise from the floor and automatically switch off with the expected delays.

-  **N.B.:** As soon as the emergency button (23) is pressed, the dedicated symbol appears on the control display (Fig. 25).

Once you have stopped the machine and solved the problem, to resume work proceed as follows:

1. Turn the main machine switch to "0", turn the key a quarter turn anti-clockwise.
2. Move the emergency switch (23) to the rest position; turn the switch as indicated by the arrows printed on it.
3. Turn the main machine switch to "", turn the key a quarter turn clockwise.

## ALARM SCREEN

When an error occurs, the corresponding alarm screen will appear on the control display (Fig. 26).

The alarm display is composed of:

- a first flashing line, which contains the alarm code (24).
- a second fixed line, which refers to the origin of the error (25).
- a third fixed line, which contains the description of the error (26).

The alarm screen will remain visible until the error is resolved; stop the machine and contact a specialist service center.

## TAG INSERTION (CFC VERSIONS)

To activate automatic fleet management data logging (valid for machine versions with CFC), after the screen that enables the machine programming features to be viewed, insert the TAG in the slot (27) on the rear part of the control handlebar (**Fig.27**).

**i** **N.B.:** if the owner of the TAG just inserted is enabled to use the machine, the screen **Fig. 28** will appear on the control display; if the TAG owner is not enabled, the screen **Fig. 29** screen will appear.

**i** **N.B.:** if the machine data connection is active, the symbol (28) will appear in the control display **Fig.4**.

## OVERFLOW DEVICE

The machine is NOT equipped with an overflow device, because the volume of the recovery tank is greater than the capacity of the solution tank. In extraordinary cases, there is a mechanical device (float) under the recovery tank lid that, when the recovery tank is full, shuts off the air to the vacuum motor intake to protect it; the sound of the suction motor will then be deeper. Empty the recovery tank (see "[EMPTYING THE RECOVERY TANK](#)").

## AT THE END OF THE WORK

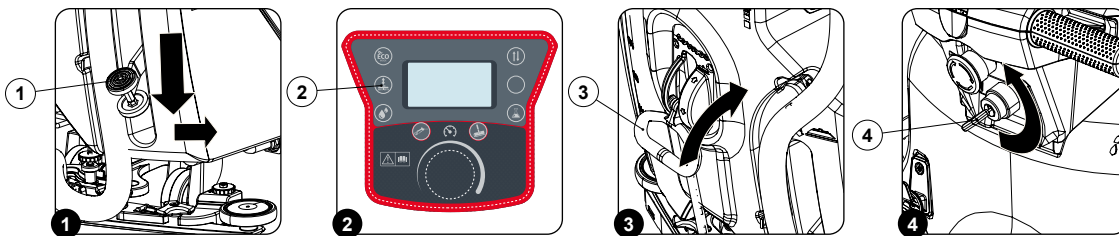

At the end of the work, and before carrying out any type of maintenance, perform the following operations:

1. Raise the brush head body and for versions without PM, depress the "BRUSH HEAD BODY CONTROL" pedal (1) at the rear of the machine fully (**Fig.1**). For versions with PM, lift the brush head body by pressing the "BRUSH HEAD CONTROL" button (2) on the control panel (**Fig.2**).

**i** **N.B.:** to lock the brush head in the raised position, depress the pedal (1) fully and then move it towards the right-hand side of the machine (**Fig.1**).

2. Raise the squeegee body and turn the squeegee control lever (3) clockwise (**Fig.3**).

3. Take the appliance to the dedicated dirty water drainage area.

4. Switch off the machine and turn the main switch (4) to position "0" by turning the key a quarter turn anti-clockwise (**Fig.4**). Remove the key from the instrument panel.

5. Carry out all the procedures listed in the chapter "[RECOMMENDED PERIODIC MAINTENANCE](#)" indicated in the column "AT THE END OF THE WORK".

6. Once the maintenance operations are complete, take the machine to the designated storage location.

**⚠ ATTENTION:** Park the machine in an enclosed place, on a flat surface; near the machine there must be no objects that could either damage it, or be damaged through contact with it.

7. Secure the machine, see the section titled "[SECURING THE MACHINE](#)".

**⚠ ATTENTION:** if the machine is left unused for more than one whole day, remove the brush from the brush head body, and the squeegee body from the squeegee support.

## RECOMMENDED MAINTENANCE OPERATIONS

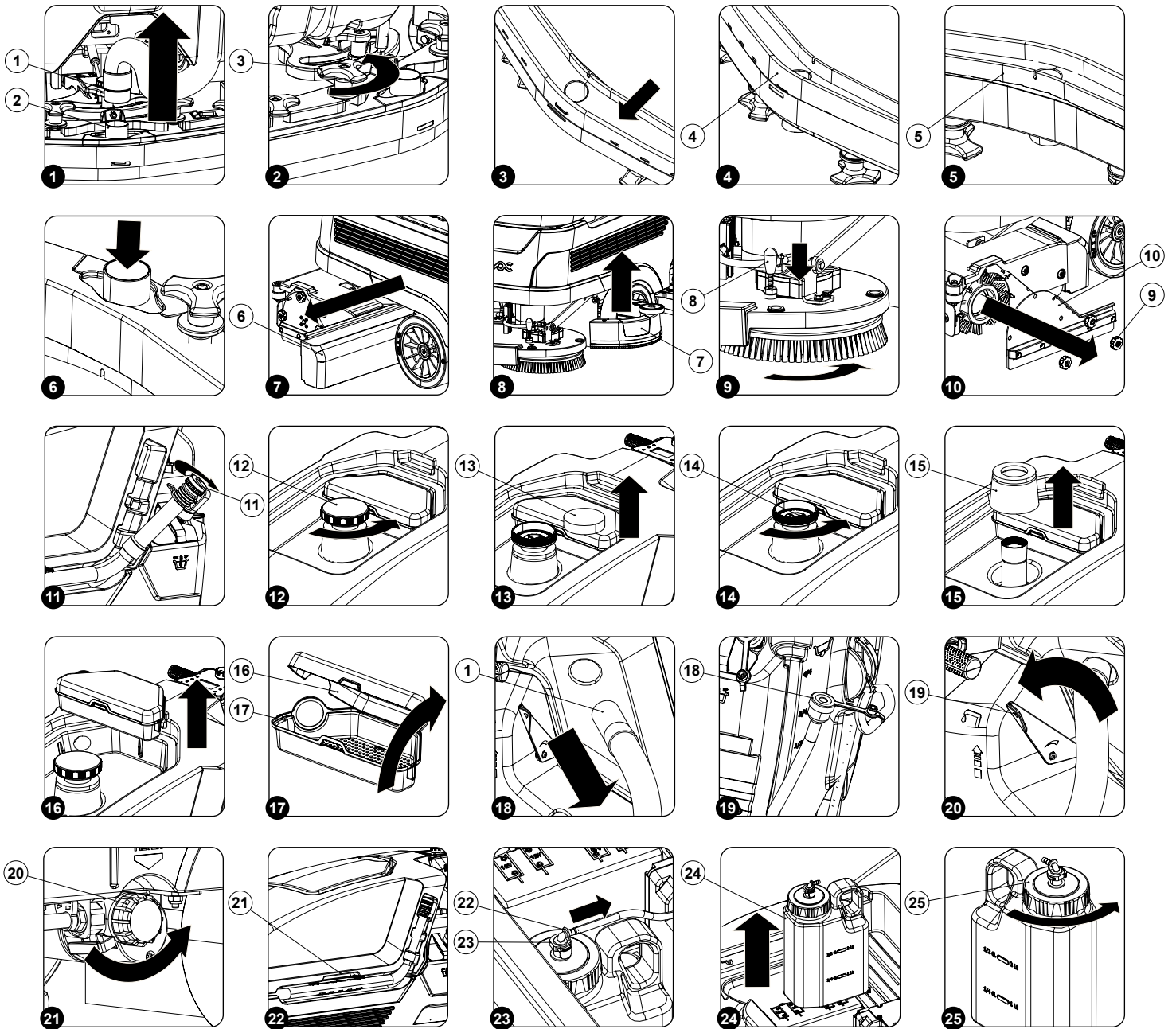

INTERVAL	MACHINE COMPONENTS	PROCEDURE
DAILY BEFORE A LONG PERIOD OF INACTIVITY	Squeegee	Clean the vacuum chamber; the squeegee rubber blades; the vacuum nozzle (see <a href="#">“CLEANING THE SQUEEGEE BODY”</a> ).
	Debris hopper	Empty the debris hopper and clean inside (see <a href="#">“CLEANING THE DEBRIS HOPPER (SWEEPING VERSION)”</a> ).
	Brush head brushes	Clean the brushes on the brush head body (see <a href="#">“CLEANING THE BRUSH HEAD BODY BRUSHES (SCRUBBING VERSION)”</a> ).
		Clean the brushes on the brush head body (see <a href="#">“CLEANING THE BRUSH HEAD BODY BRUSHES (SWEEPING VERSION)”</a> ).
	Recovery tank	At the end of every working day, empty the recovery tank (see <a href="#">“EMPTYING THE RECOVERY TANK”</a> ).
		At the end of every working day, after having emptied the recovery tank, clean the vacuum system filters (see <a href="#">“CLEANING THE RECOVERY TANK FILTERS”</a> ).
		At the end of every working day, after having emptied the recovery tank, clean the vacuum tube (see <a href="#">“CLEANING THE VACUUM TUBE”</a> ).
Solution tank	At the end of every working day, empty the solution tank (see <a href="#">“EMPTYING THE SOLUTION TANK”</a> ).	
WEEKLY	Machine water system	Clean the filter in the machine's water system (see <a href="#">“CLEANING THE WATER SYSTEM FILTER”</a> ).
		Clean the detergent tank located inside machine, valid for versions with CDS (see <a href="#">“CLEANING THE DETERGENT TANK (CDS VERSIONS)”</a> ).
	Squeegee rubber blades	Check that the rubber blades on the squeegee body are intact and inspect for wear; if necessary, replace these (see <a href="#">“REPLACING THE SQUEEGEE BODY RUBBER BLADES”</a> ).
Brush head brushes	Check that the brushes on the brush head body are intact and inspect for wear; if necessary, replace these (see <a href="#">“REPLACING THE BRUSH HEAD BODY BRUSHES (SCRUBBING VERSION)”</a> ).	
	Check that the brushes on the brush head body are intact and inspect for wear; if necessary, replace these (see <a href="#">“REPLACING THE BRUSH HEAD BODY BRUSHES (SWEEPING VERSION)”</a> ).	
MONTHLY	Squeegee rubber blade levelling	Check that the rubber blades on the squeegee body are level and if necessary, adjust these (see <a href="#">“ADJUSTING THE SQUEEGEE BODY RUBBER BLADES”</a> ).

Before carrying out any routine maintenance operations, proceed as follows:

1. Take the machine to the maintenance area.



**N.B.:** the place given over to this operation must comply with current environmental protection regulations.

2. Make sure the machine is in a safe condition (see chapter "[MACHINE SAFETY MEASURES](#)").

**⚠ CAUTION:** It is recommended that you wear the PPE (Personal Protective Equipment) suited to the work to be carried out.

## CLEANING THE SQUEEGEE BODY

The careful cleaning of the whole vacuum unit ensures better drying and cleaning of the floor as well as a longer vacuum motor life. To carry out the cleaning of the squeegee body, proceed as follows:

1. Remove the vacuum hose (1) from the vacuum nozzle (2) on the squeegee body (**Fig.1**).
2. Completely unscrew the knobs (3) on the squeegee body pre-assembly (**Fig.2**).
3. Remove the squeegee body from the slits in the squeegee connector.
4. Thoroughly clean the squeegee body vacuum chamber with a jet of water, and then with a damp cloth (**Fig.3**).
5. Thoroughly clean the squeegee body's rear rubber blade (4) with a jet of water, and then with a damp cloth (**Fig.4**).
6. Thoroughly clean the squeegee body front rubber blade (5) with a jet of water, and then with a damp cloth (**Fig.5**).
7. Use a jet of water and then a damp cloth to thoroughly clean the vacuum nozzle (**Fig.6**).
8. Proceed in the opposite order to reassemble all the parts.



**N.B.:** Check the wear of the rear rubber blade (4) and the front rubber blade (5) on the squeegee body; if the edge of the rubber in contact with the floor is worn, replace it. Refer to "[REPLACING THE SQUEEGEE BODY RUBBER BLADES](#)".

## CLEANING THE DEBRIS HOPPER (SWEEPING VERSION)

To clean the debris hopper, proceed as follows:

1. Use the moulded handle to extract the debris hopper (6) (**Fig.7**) and empty it.
2. Clean the inside with a jet of water, and use a brush to remove any residual impurities if necessary.
3. Proceed in the opposite order to reassemble all the parts.

## CLEANING THE BRUSH HEAD BRUSHES (SCRUBBING VERSION)

Careful cleaning of the brush guarantees better cleaning of the floor, as well as a longer brush head gearmotor lifespan. To clean the brush, proceed as follows:

1. Go to the front of the machine.
2. With the brush head in the raised position, remove the brush head splash guards (7) (**Fig.8**).
3. Press the brush-holder plate retainer (8) and simultaneously rotate the brush in the direction shown in the image (**Fig.9**).



**ATTENTION:** **Fig.9** shows the rotation direction of the left-hand brush.

4. When brush rotation is prevented, turn until the button on the brush is disengaged from the coupling spring on the brush-holder plate.
5. Repeat the same operation for the right-hand brush.
6. Clean the brush under running water to remove any impurities from its bristles.
7. See "[INSTALLING THE BRUSH \(SCRUBBING VERSION\)](#)" for instructions on refitting the brushes in the brush head body.



**N.B.:** Check that the bristles are not worn; in the event of excessive wear, replace the brush (the bristles should be at least 10 mm long). See "[REPLACING THE BRUSH \(SCRUBBING VERSION\)](#)" to replace the brush.

## CLEANING THE BRUSH HEAD BRUSHES (SWEEPING VERSION)

Careful cleaning of the brush guarantees better cleaning of the floor, as well as a longer brush head gearmotor lifespan. To clean the brush, proceed as follows:

1. Go to the front of the machine.
2. With the brush head raised from the floor, turn the knobs (9) that hold the left lateral carter (10) in place anti-clockwise (**Fig.10**). Remove the left-hand side carter.
3. Remove the brushes from the tunnel.
4. Repeat the same operation for the right-hand brush.
5. Clean the brush under running water to remove any impurities from its bristles.
6. See "[INSTALLING THE BRUSH \(SWEEPING VERSION\)](#)" for instructions on refitting the brushes in the brush head body.



**N.B.:** Check that the bristles are not worn; in the event of excessive wear, replace the brush (the bristles should be at least 10 mm long). See "[REPLACING THE BRUSH \(SWEEPING VERSION\)](#)" to replace the brush.

## DRAINING THE RECOVERY TANK

Proceed as follows to empty the recovery tank:

1. Release the recovery tank drainage tube (11) (on the left-hand side of the machine) from the retainers (**Fig.11**).
2. Bend the end of the drainage tube, so as to create a choke and prevent the contents from coming out, put the tube on the discharge surface, unscrew the cap and gradually release the tube.
3. Repeat the operations in reverse order to reassemble all the parts.

## CLEANING THE RECOVERY TANK FILTERS

To clean the recovery tank (without the optional tank cleaning kit), proceed as follows:

1. Make sure the recovery tank is empty. If this is not the case, empty it (read "[EMPTYING THE RECOVERY TANK](#)").
2. Remove the recovery tank cover.
3. Remove the float cover (12), turning it in the direction of the arrow (**Fig.12**).
4. Remove the vacuum filter (13) and clean it (**Fig.13**).

 **N.B.:** you are advised to use a jet of air to remove the impurities before cleaning the filter. Position the filter at least 20cm from the air jet.

 **ATTENTION:** do not use highly corrosive products to clean the filter, to avoid damaging it.

 **N.B.:** If the vacuum filter is excessively worn or damaged, contact the nearest service centre to replace it.

5. Remove the upper part of the float (14), turning it in the direction of the arrow (**Fig.14**).

 **N.B.:** when removing the upper part of the float, be very careful not to remove the lower part as well.

6. Remove the float (15) (**Fig.15**). Rinse the inside with a jet of water. If necessary, use a spatula to remove the sludge that has accumulated at the bottom of the float.

 **N.B.:** If the polyurethane ring on the float body (**Fig.15**) is excessively worn or damaged, contact the nearest service centre to replace it.

7. Remove the dirty water basket/filter from the support (**Fig.16**).
8. Remove the cover (16) from the basket-filter (17) (**Fig.17**) and clean under a jet of running water.

 **N.B.:** Use a spatula or brush to eliminate any dirt that is particularly difficult to remove.

9. Repeat the operations in reverse order to reassemble all the parts.

## CLEANING THE VACUUM TUBE

Careful cleaning of the vacuum hose guarantees better cleaning of the floor as well as a longer vacuum motor life. Proceed as follows to clean the vacuum hose:

1. Stand at the back of the machine.
2. Remove the vacuum hose (1) from the vacuum nozzle (2) on the squeegee body (**Fig.1**).
3. Remove the vacuum tube (1) via the hole on the back of the recovery tank (**Fig.18**).
4. Rinse the inside of the vacuum hose with a jet of running water.
5. Repeat the operations in reverse order to reassemble all the parts.

## EMPTYING THE SOLUTION TANK

Proceed as follows to empty the solution tank:

1. Release the solution tank drainage tube (18) (on the left-hand side of the machine) from the retainers (**Fig.19**).
2. Remove the cap and empty the tank; with the solution tank empty, rinse the inside of the solution tank with a jet of running water.
3. Repeat the operations in reverse order to reassemble all the parts.

## CLEANING THE WATER SYSTEM FILTER

In order to clean the water system's filter, do the following:

1. Block the tap outflow, rotating the knob (19) in the direction of the arrow (**Fig.20**).
2. Go to the right-hand side of the machine and loosen the detergent solution filter cap (20) (**Fig.21**).
3. Remove the filter cartridge and rinse under a jet of water, using a brush to eliminate any impurities if necessary.
4. Once the filter cartridge is clean, repeat the operations in the opposite order to reassemble all the parts.

## CLEANING THE DETERGENT TANK (CDS VERSIONS)

To clean the canister, proceed as follows:

1. Grip the handle (21) on the left-hand side of the recovery tank (Fig.22) and turn the tank as far as it will go.
2. Disconnect the male insert (22) from the female insert (23) on the cap of the detergent canister (Fig.23).

**i** **N.B.:** Before pulling on the male insert, push the lever in the female insert.

3. Grip the handle on the detergent canister (24) to remove it from the compartment in the solution tank (Fig.24).
4. Unscrew the cap (25) of the detergent canister (Fig.25).
5. Clean the tank with a jet of running water.
6. Repeat the operations described above in reverse order to reassemble all the parts.

## EXTRAORDINARY MAINTENANCE WORK

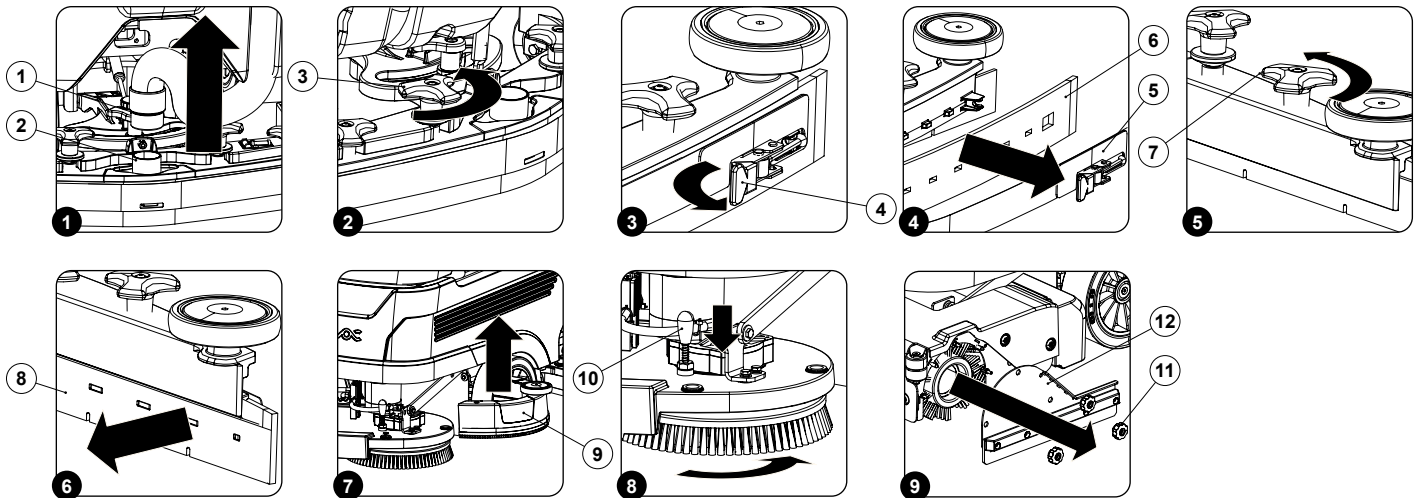

Before carrying out any routine maintenance operations, proceed as follows:

1. Take the machine to the maintenance area.

**♻️** **N.B.:** The place given over to this operation must comply with current environmental protection regulations.

2. Make sure the machine is in a safe condition (see chapter "[MACHINE SAFETY MEASURES](#)").

**⚠️ CAUTION:** It is recommended that you wear the PPE (Personal Protective Equipment) suited to the work to be carried out.

## REPLACING THE SQUEEGEE BODY RUBBER BLADES

Ensuring the integrity of the squeegee body's rubber blades guarantees better floor cleaning and drying results, as well as a longer service life for the vacuum motor. In order to replace the squeegee body's rubber blades, do the following:

1. Remove the vacuum hose (1) from the vacuum nozzle (2) on the squeegee body (Fig.1).
2. Completely unscrew the knobs (3) on the squeegee body pre-assembly (Fig.2).
3. Remove the squeegee body from the slits in the squeegee connector.

**To remove the rear squeegee rubber blade, proceed as follows:**

- Remove the rear rubber blade compression plate (5), and release the stop (4) at the rear of the squeegee (Fig.3).
- Remove the rear rubber blade (6) from the squeegee body (Fig.4).
- Replace the worn rubber blade with a new one.

**i** **N.B.:** The rubber blade can be rotated symmetrically to be used more than once.

- Repeat the operations in reverse order to reassemble all the parts.

**To remove the front squeegee rubber blade, proceed as follows:**

- Completely unscrew the knobs (7) on the squeegee body pre-assembly (Fig.5); this will cause the internal squeegee body to move downwards, and the front rubber blade can then be removed.
- Remove the front rubber blade (8) from the squeegee's internal body (Fig.6).
- Replace the worn rubber blade with a new one.

**i** **N.B.:** The rubber blade can be rotated symmetrically to be used more than once.

- Repeat the operations in reverse order to reassemble all the parts.

**i** **N.B.:** Before using the machine, remember to adjust the squeegee body: see the section titled "[ADJUSTING THE SQUEEGEE BODY'S RUBBER BLADES](#)".

**i** **N.B.:** It is recommended to replace both squeegee body blades in order to ensure good results when drying the floor.

## REPLACING THE BRUSH (SCRUBBING VERSION)

The good condition of the brush guarantees better cleaning of the floor, as well as a longer brush head gearmotor lifespan. To replace the brush, proceed as follows:

1. Go to the front left-hand side of the machine.
2. With the brush head in the raised position, remove the brush head splash guards (9) (**Fig.7**).
3. Press the brush-holder plate retainer (10) and simultaneously rotate the brush in the direction shown in the image (**Fig.8**).
4. Repeat the same operation for the right-hand brush.
5. See "[INSTALLING THE BRUSH \(SCRUBBING VERSION\)](#)" for instructions on fitting the new brushes in the brush head body.

## REPLACING THE BRUSH (SWEEPING VERSION)

The good condition of the brush guarantees better cleaning of the floor, as well as a longer brush head gearmotor lifespan. To replace the brush, proceed as follows:

1. Go to the front left-hand side of the machine.
2. With the brush head raised from the floor, turn the knobs (11) that hold the left lateral carter (12) in place anti-clockwise (**Fig.9**).
3. Remove the left-hand side carter and extract the brush from the tunnel.
4. Repeat the same operation for the right-hand brush.
5. See "[INSTALLING THE BRUSH \(SWEEPING VERSION\)](#)" for instructions on fitting the new brushes in the brush head body.

## ADJUSTMENT INTERVENTIONS

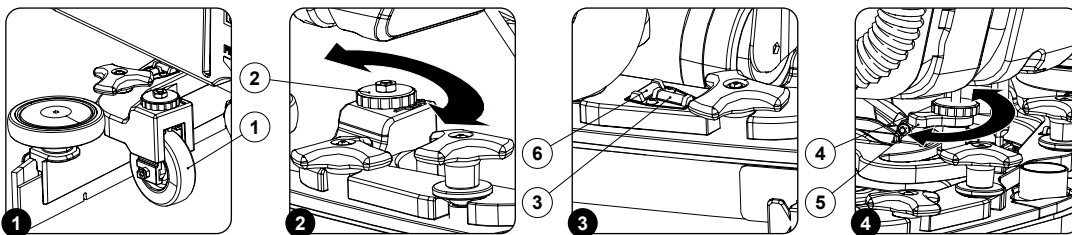

Before carrying out any adjustments, proceed as follows:

1. Take the machine to the maintenance area.

 **N.B.:** the place given over to this operation must comply with current environmental protection regulations.

2. Make sure the machine is in a safe condition (see chapter "[MACHINE SAFETY MEASURES](#)").

 **CAUTION:** It is recommended that you wear the PPE (Personal Protective Equipment) suited to the work to be carried out.

## ADJUSTING THE SQUEEGEE BODY'S RUBBER BLADES

The careful adjustment of the squeegee body rubber blades guarantees better cleaning of the floor.

**To adjust the height of the squeegee body:**

1. The distance of the squeegee rubber blades from the floor can be adjusted by changing the distance between the wheels (1) located on the squeegee support and the floor itself (**Fig.1**).
2. To adjust the height of the wheels, simply use the adjustment knobs (2) located on the squeegee support (**Fig.2**).

**i** **N.B.:** To decrease the distance between the wheels and the floor, simply turn the adjustment levers (2) in the direction indicated by the arrows with the sign "-", while to increase the distance just follow the arrows with the "+" sign.

**i** **N.B.:** By decreasing the distance between the squeegee support and the floor, the rubber blades present in the squeegee's body move closer to the floor.

**i** **N.B.:** For effective drying, the wheels must be at the same distance from the floor.

**i** **N.B.:** Check for proper adjustment by looking at the instrument (3) positioned on the squeegee body (**Fig.3**).



### Adjusting the tilt of the squeegee body:

- The angle of tilt of the squeegee body is adjusted by rotating the lever (5) located on the squeegee support (**Fig.4**).
- To adjust the tilt of the squeegee body, loosen the knob (4) and tighten or loosen the lever (5) (**Fig.4**), until the squeegee body rubber blades are bent towards the outside evenly along the entire length by about 30° with respect to the floor.

**i** **N.B.:** Check for proper adjustment by looking at the instrument (6) positioned on the squeegee body (**Fig.3**).

**i** **N.B.:** Moving the lever (5) clockwise will raise the central part of the squeegee body from the floor.

- Once the adjustment has been completed, tighten the knob (4).

## CHOOSING AND USING BRUSHES

### POLYPROPYLENE BRUSH (PPL)

Used on all types of floors. Good resistance to wear and tear, and hot water (no greater than 50°C.). PPL is non-hygroscopic and therefore retains its characteristics even when working in wet conditions.

### ABRASIVE BRUSH

The bristles of this type of brush are charged with highly aggressive abrasives. It is used to clean very dirty floors. To avoid floor damage, work only with the pressure strictly necessary.

### BRISTLE THICKNESS

Thicker bristles are more rigid and are therefore used on smooth floors or floors with small joints.

On uneven floors or those with deep joints, it is advisable to use softer bristles which can enter the gaps more easily.

Remember that when the bristles are worn and therefore too short, they will become rigid and are no longer able to penetrate and clean deep down. In this case, like with over-large bristles, the brush tends to jump.

### ABRASIVE PAD:

- RED PAD** (for cleaning operations and routine maintenance):  
Red pad made from polyester fibres, flexible for greater adherence to surfaces and for easier washing after use. The special composition of the brush, which features thin fibres, enables marks to be removed whilst polishing surfaces. When used for damp cleaning, the brush can also remove streaks and black marks. When used dry, it polishes and restores shine to surfaces. Ideal for any type of flooring, even materials with protective coating.
- BLACK PAD** (for full de-waxing operations):  
Black pad with nylon fibres containing highly abrasive aluminium oxide particles bonded with synthetic resin. Suitable for the complete removal of even the toughest wax layers (stripping). It can also be used for deep cleaning operations on hard floors, such as concrete.
- GREEN PAD** (for partial de-waxing operations and deep cleaning on hard surfaces):  
Green pad with nylon fibres containing silicon carbide particles with medium abrasiveness, bonded with synthetic resin. Flexible disc for greater adherence to surfaces and for easier washing after use. Ideal for the partial removal of superficial layers of wax and for preparing floors to be re-waxed (scrubbing). It can also be used for heavy duty cleaning on tough and very dirty surfaces, without affecting the shine of the floor. Ideal for concrete floors, unprotected hard surfaces, vinyl tiles, stone, non-fragile ceramic, linoleum and PVC.
- WHITE PAD** (for polishing operations):  
White pad made from polyester fibres, flexible for greater adherence to surfaces and for easier washing after use. Ideal for mirror polishing (buffing) of floors treated with metallic waxes. The very thin fibres increase surface shine without scratching. The white disc must be used dry, or with a light spray application.

MACHINE	CODE	QTY	BRISTLE	NOTES
Vega 2019 65Bt	422189	2	PPL 0.3	LIGHT BLUE DISC BRUSH
	422971	2	PPL 0.6	WHITE DISC BRUSH
	422972	2	PPL 0.9	BLACK DISC BRUSH
	422981	2	ABRASIVE	GREY DISC BRUSH
	422973	2	-	PAD HOLDER
Vega 2019 75Bt	414272	2	PPL 0.3	LIGHT BLUE DISC BRUSH
	414270	2	PPL 0.6	WHITE DISC BRUSH
	414273	2	PPL 0.9	BLACK DISC BRUSH
	414271	2	ABRASIVE	GREY DISC BRUSH
	405508	2	-	PAD HOLDER
Vega 2019 85Bt	445562	2	PPL 0.3	LIGHT BLUE DISC BRUSH
	445563	2	PPL 0.6	WHITE DISC BRUSH
	445564	2	PPL 0.9	BLACK DISC BRUSH
	445565	2	ABRASIVE	GREY DISC BRUSH
	421819	2	-	PAD HOLDER

MACHINE	CODE	QTY	BRISTLE	NOTES
Vega 2019 70Bto	442638	1	-	RED ABRASIVE PAD
	442663	1	-	GREEN ABRASIVE PAD
	442664	1	-	BLACK ABRASIVE PAD
	443713	1	-	WHITE ABRASIVE PAD
Vega 2019 70Bts	449785	2	PPL 0.3	BLUE CYLINDRICAL BRUSH
	448012	2	PPL 0.6	WHITE CYLINDRICAL BRUSH
	448013	2	PPL 0.9	BLACK CYLINDRICAL BRUSH
	448014	2	ABRASIVE	GREY CYLINDRICAL BRUSH

## TROUBLESHOOTING

This chapter lists the most common problems linked with the use of the machine. If you are unable to resolve the problems with the information given here, please contact your nearest assistance centre.

PROBLEM	POSSIBLE CAUSE	SOLUTION
THE MACHINE DOES NOT START	The main switch is set to "0".	Make sure the main switch is on "I". If it isn't, turn the key clockwise.
	Check that when switched on there are no alarm messages on the command display.	Stop the machine immediately and contact the technician of the specialised service centre, or press the SOS button if the HFM kit is installed.
	Make sure that the batteries are correctly connected to each other and that the battery connector is connected to the electrical system connector.	Connect the batteries correctly inside the machine (see <a href="#">INSERTING THE BATTERIES IN THE MACHINE</a> ”).
	Check the charge level of the batteries.	If the battery charge level is critical, perform a complete recharge cycle (see paragraph <a href="#">RECHARGING THE BATTERIES</a> ”).
THE BATTERIES ARE NOT CHARGED CORRECTLY (VERSIONS WITH AN ON BOARD BATTERY CHARGER)	The plug on the battery charger's cable is not correctly inserted into the socket on the battery charger itself.	Reconnect the battery charger's power cable.
	The plug on the battery charger's power cable is not correctly inserted into the electrical outlet.	Check that the battery charger power supply cable plug is connected to the mains socket.
	The characteristics of the mains power supply do not correspond to those required by the battery charger.	Check that the characteristics in the battery charger plate are the same as those of the mains supply.
	The LEDs of the battery charger blink repeatedly.	Referring to the battery charger use and maintenance manual, check the meaning of the flashing signals that the battery charger emits during the battery recharge stage.
THE MACHINE HAS A VERY LOW WORK AUTONOMY	Check the battery charge level, check the symbol on the command display.	If the battery charge level is critical, perform a complete recharge cycle (see <a href="#">"RECHARGING THE BATTERIES"</a> ”).
THE MACHINE DOES NOT MOVE	The machine does not start.	Read the section <a href="#">"THE MACHINE DOES NOT START"</a> .
	There is an issue on the drive pedal.	Contact your nearest service centre.
NOT ENOUGH DETERGENT SOLUTION ON THE BRUSH	The quantity of detergent solution in the water system is not sufficient for the work to be carried out.	Check that the amount of detergent solution present in the machine's water system is sufficient for the work to be carried out.
	Detergent solution filter obstructed.	Check the detergent solution filter isn't obstructed. If it is, clean it (see <a href="#">"CLEANING THE WATER SYSTEM FILTER"</a> ”).
THE MACHINE DOES NOT CLEAN CORRECTLY	The machine does not start.	Read the section <a href="#">"THE MACHINE DOES NOT START"</a> .
	Not enough detergent solution comes out.	Read the section <a href="#">"NOT ENOUGH DETERGENT SOLUTION ON THE BRUSH"</a> .
	The brushes have not been inserted correctly in the machine.	Check that the disc brushes are correctly inserted into the machine (see <a href="#">"ASSEMBLING THE BRUSH (SCRUBBING VERSION)"</a> or <a href="#">"ASSEMBLING THE BRUSH (SWEEPING VERSION)"</a> ”).
	The type of brush used is not suitable for the dirt to be cleaned.	Make sure that the brushes fitted on the machine are suitable for the work to be carried out. Read <a href="#">"CHOOSING AND USING THE BRUSHES"</a> .
	The brush bristles are excessively worn.	Check the wear of the brush and if necessary replace it (see <a href="#">"REPLACING THE BRUSH (SCRUBBING VERSION)"</a> or <a href="#">"REPLACING THE BRUSH (SWEEPING VERSION)"</a> ”).

PROBLEM	POSSIBLE CAUSE	SOLUTION
THE SQUEEGEE DOES NOT DRY PERFECTLY	The vacuum unit is obstructed.	Make sure the squeegee is free of obstructions (read " <a href="#">CLEANING THE SQUEEGEE BODY</a> ").
		Make sure the vacuum tube is free of obstructions (see " <a href="#">CLEANING THE VACUUM TUBE</a> ").
		Make sure the vacuum cap filter is free of obstructions (see " <a href="#">CLEANING THE RECOVERY TANK FILTERS</a> ").
		Make sure the suction motor filter is free of obstructions (see " <a href="#">CLEANING THE RECOVERY TANK FILTERS</a> ").
	The cap on the recovery tank drainage tube is not properly positioned.	Check that the cap on the recovery tank drainage tube is positioned properly.
	The recovery tank lid is not positioned correctly.	Check that the recovery tank lid is properly positioned on the machine.
EXCESSIVE FOAM PRODUCTION	The detergent being used is not suitable.	Check that a low foam detergent has been used. If necessary, add a small quantity of anti-foam liquid to the recovery tank.
	The floor is not very dirty.	Dilute the detergent more.
THE MACHINE DOES NOT VACUUM CORRECTLY	The recovery tank is full.	Empty the recovery tank (read " <a href="#">EMPTYING THE RECOVERY TANK</a> ").
	The vacuum device is obstructed	Read the section " <a href="#">THE SQUEEGEE DOES NOT DRY PERFECTLY</a> ".

## EC DECLARATION OF CONFORMITY



The undersigned manufacturer:  
**COMAC S.p.A.**  
Via Maestri del Lavoro, 13  
37059 Santa Maria di Zevio (VR)  
declares under its sole responsibility that the products

### FLOOR SCRUBBING MACHINES

**mod. Vega 2019 65Bt; Vega 2019 75Bt; Vega 2019 85Bt; Vega 2019 70Bto; Vega 2019 70Bts**

comply with the provisions of Directives:

- 2006/42/EC: Machinery Directive.
- 2014/30/EC: Electromagnetic compatibility directive.

They also comply with the following standards:

- EN 60335-1:2012/A11:2014
- EN 60335-2-72:2012
- EN 12100:2010
- EN 61000-6-2:2005/AC:2005
- EN 61000-6-3:2007/A1:2011/AC:2012
- EN 62233:2008/AC:2008

The person authorized to compile the technical file:

Mr. Giancarlo Ruffo  
Via Maestri del Lavoro, 13  
37059 Santa Maria di Zevio (VR) - ITALY  
Santa Maria di Zevio (VR), 19/06/2019

Comac S.p.A.  
Legal representative  
Giancarlo Ruffo

The undersigned manufacturer:  
**COMAC S.p.A.**  
Via Maestri del Lavoro, 13  
37059 Santa Maria di Zevio (VR)  
declares under its sole responsibility that the products

**FLOOR SCRUBBING MACHINES**  
**mod. Vega 2019 65Bt CB; Vega 2019 75Bt CB; Vega 2019 85Bt CB; Vega 2019 70Bto CB;**  
**Vega 2019 70Bts CB**

comply with the provisions of Directives:

- 2006/42/EC: Machinery Directive.
- 2014/35/EC: Low Voltage Directive.
- 2014/30/EC: Electromagnetic compatibility directive.

They also comply with the following standards:

- EN 60335-1:2012/A11:2014
- EN 60335-2-72:2012
- EN 12100:2010
- EN 60335-2-29:2004/A2:2010
- EN 61000-6-2:2005/AC:2005
- EN 61000-6-3:2007/A1:2011/AC:2012
- EN 61000-3-2:2014
- EN 61000-3-3:2013
- EN 55014-1:2006/A1:2009/A2:2011
- EN 55014-2:2015
- EN 62233:2008/AC:2008

The person authorized to compile the technical file:

Mr. Giancarlo Ruffo  
Via Maestri del Lavoro, 13  
37059 Santa Maria di Zevio (VR) - ITALY  
Santa Maria di Zevio (VR), 19/06/2019

Comac S.p.A.  
Legal representative  
Giancarlo Ruffo

