

Vacuum Cleaner

CG-4080

Instruction Manual

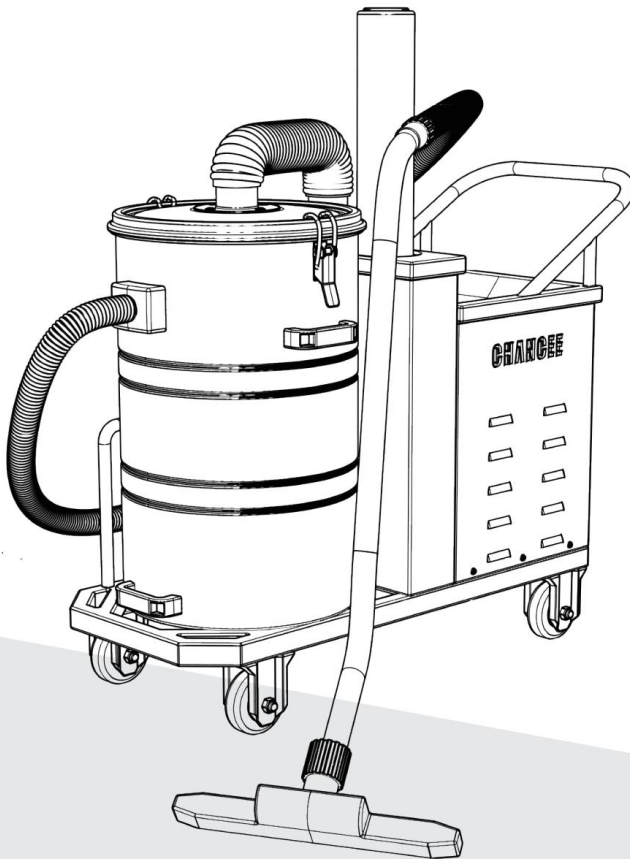

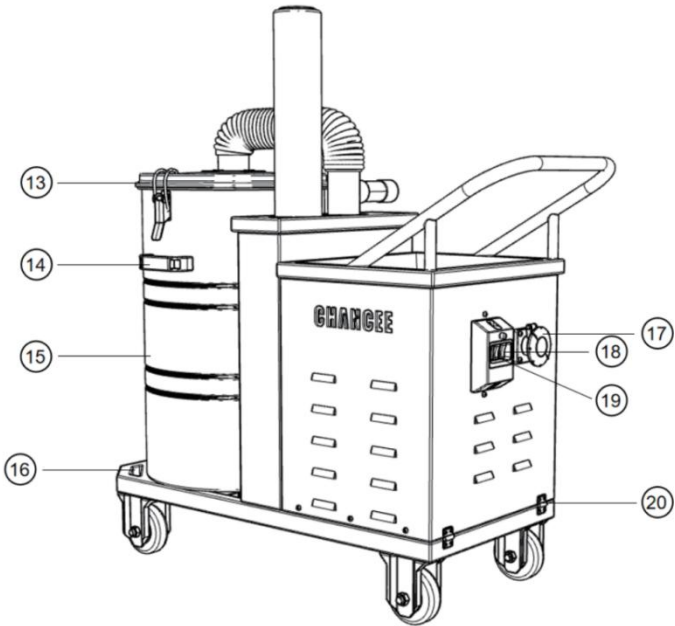
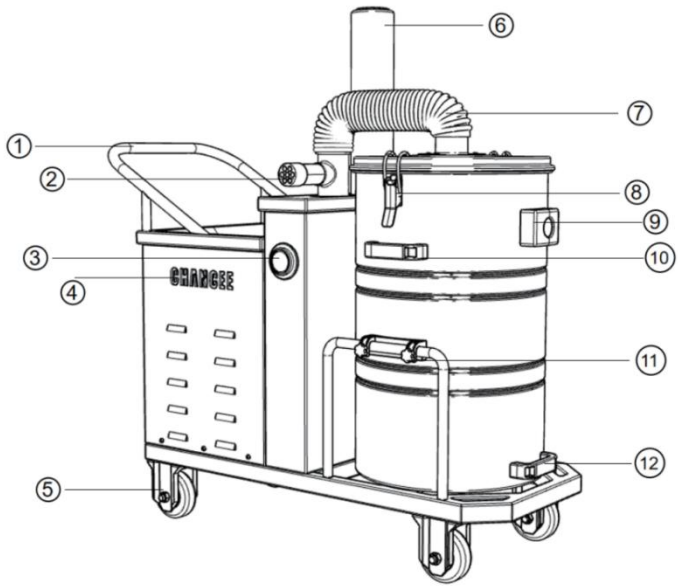

21



22



23



24

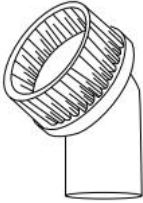

25



26



27

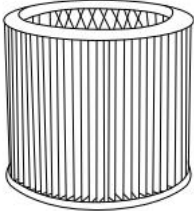

28

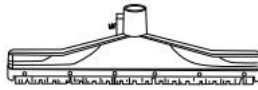

29

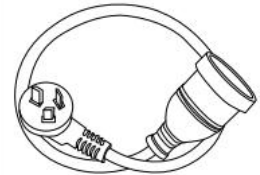

- | | | | | | |
|----|-----------------------------|----|-----------------|----|-------------------|
| 1 | Handrail | 11 | Flip-up latch | 21 | High-quality hose |
| 2 | Heat dissipation channel I | 12 | Handle II | 22 | Joint pipe A&B |
| 3 | Pressure gauge | 13 | Dustbin cover | 23 | Absorbent brush |
| 4 | Brand name | 14 | Handle III | 24 | Circular brush |
| 5 | Universal wheel | 15 | Dustbin | 25 | Dust compartment |
| 6 | Heat dissipation channel II | 16 | Bottom plate | 26 | Flat nozzle |
| 7 | Suction channel | 17 | Connection port | 27 | HEPA |
| 8 | Buckle | 18 | Turn-on switch | 28 | Vacuuming brush |
| 9 | Sewage suction channel | 19 | Turn-off switch | 29 | Charging cable |
| 10 | Handle I | 20 | Hinge | | |

Operation process

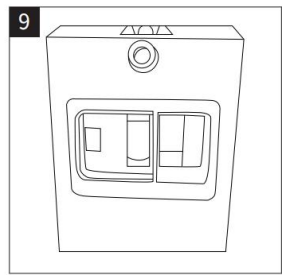
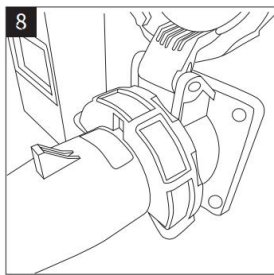
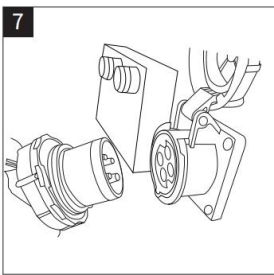
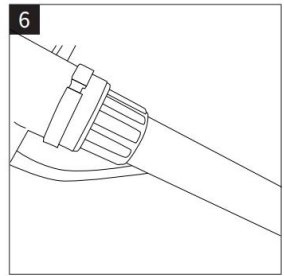
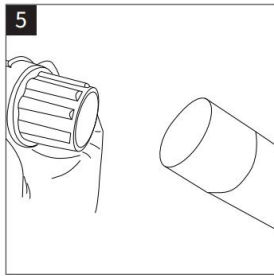
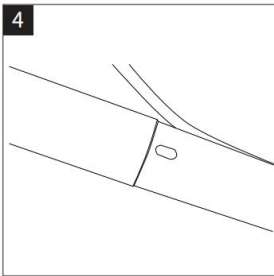
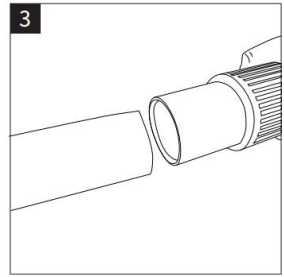
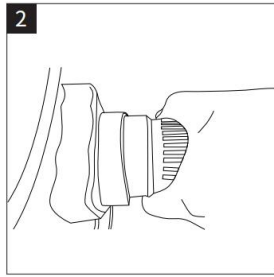
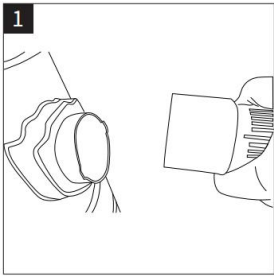

- Align the front end of the hose with the suction channel port.
- Connect and fix the hose.
- Connect the pipe A to the hose.
- Align and connect the pipe A and the pipe B.
- Connect the pipe B with the accessories.
- Tighten the retaining ring of the absorbent brush or the vacuuming brush.
- Open the terminal cover and insert the terminal.
- Tighten the retaining ring.
- Click the black start switch to start the machine.

Preface

This instruction manual contains all the information that you need to use and maintain the machine. Please read it carefully before getting started.

If this manual is lost, please contact us immediately and we will be glad to provide you with a new one.

In this manual we use illustrations to show the components and functions of the machine. It is possible that some of them contain details that are slightly different from those of yours. However, all the instructions and suggestions presented here still apply to your product and should be followed strictly during the operation.

Some components of the product may be harmful or dangerous and we have tried our best to include them in this manual. It is the user's obligation to pay special attention to them during the work. However, since it is impossible for us to point out all potential dangers, we expect you to be extremely cautious during the work so as to protect the machine, yourself and other people in the working area.

Only accessories of the original manufacturer can be used on the machine. Using accessories from other sources may lead to low working efficiency or even accidents in extreme cases.

We usually modify or improve our products to meet the latest market demand. However, this is NOT suitable for machines that have been sold. We will NOT be responsible for any injury or loss caused due to the user's improper operation either.

If you have any question, complaint or suggestion, please feel free to contact us and we will be at your service with all our knowledge and enthusiasm.

Contents

Technical parameters	1
Safety regulations	2
Precautions	2
Potential dangers	3
Installation	3
Before work	3
Dustbin	3
Maintenance	3
Replacement of the filter screen	4
Common problems and solutions	4
After-sale services	5
Warranty card	6

Technical parameters

Category	Parameter
Voltage	380 V
Power	4,000 W
Vacuum degree	318/31.8 (mbar/kPa)
Filtering efficiency	0.3 μ m
Dustbin capacity	80 L
Dustbin material	Stainless steel
Steel pipe length	0.5 * 2 m
Hose length	2.5 m
Noise level	68 db
Working time	24 h
Frequency	50 - 60 Hz
Power cord length	5 m
Product size	L: 1,145 mm W: 585 mm H: 1,270 mm

Safety regulations

It is the safety officer's obligation to inform operators of potential risks during the use of the machine and provide necessary training so that they can protect themselves and other people in the working area. Such risks as well as other instructions can be found in this manual. Accidents may occur when basic safety rules are ignored during the operation, maintenance or repair of the product, and can be avoided when the user is well aware of potential dangers and precautions that should be taken. The company will NOT be responsible for any damage caused if the user fails to observe the instructions presented in this manual or if the machine is operated by untrained or incompetent personnel.

Precautions

- Before maintaining the machine, make sure that the power is disconnected.
- Read this manual carefully before operating the machine. Children and disabled people are strictly forbidden to use the machine.
- The machine can be used to clean toxic substances only when equipped with a special filter screen, and such equipment will be provided only if the customer makes a request.
- The machine can be used to clean flammable or explosive substances only when equipped with explosion-proof motors and electrical system, and such equipment will be provided only if the customer makes a request.
- The machine can be used to clean corrosive substances only when equipped with a corrosion-proof liquid tank, and such equipment will be provided only if the customer makes a request.
- Do NOT use the machine when it is not equipped with a filter screen.
- Do NOT change the direction when the machine is working on a slope.
- Use the brake wheels before parking the machine.
- The machine can only be repaired by professional personnel.
- Check the power cord regularly to make sure that it is not damaged or broken.
- If the plug and the power cord are broken, please replace them with water-proof alternatives.
- Do NOT use the machine in places with corrosive, flammable or explosive substances.
- Do NOT use the machine to clean substances that may affect its operation.
- Do NOT use flammable or toxic detergent.
- Do NOT use the machine to clean cigarette butts that are still burning.
- Do NOT use the machine to clean gasoline or other solvent.

Potential dangers

- Before operating the machine, please be aware of potential dangers that the original manufacturer indicates in this part, and take precautions to prevent them. Use the safety device provided with or attached to the machine.
- Danger of the power: only trained and competent personnel can operate the machine; make sure that it is equipped with double ground insulation.
- Danger of flammable and explosive substances: the vacuum cleaner cannot be used to clean flammable or explosive matters.
- Danger of damp environment.
- Danger of misunderstanding of the signs of danger: the manufacturer has attached signs of danger to the machine according to relevant regulations. When the signs of danger become unclear, replace them immediately.



- Do NOT remove any danger signs from the machine body.
- The original manufacturer will NOT be responsible for any accident if the user fails to follow the instructions above.

Installation

- Before installing the machine, check whether there is any damage caused during the transportation.
- If there is any damaged accessory, please contact us immediately.
- The machine is equipped with a dust compartment and a vacuum filter.
- Install accessories on the other end of the hose; insert the hose on the transition pipe; connect the round brush and the flat nozzle directly to the hose; use the S-shaped elbow with the vacuum brush to realize the cleaning work.

Before work

- Before connecting the power, make sure that the voltage of the power supply is consistent with that on the metal label.
- Check whether the plug matches the socket.
- Check whether the hose matches the suction port.
- Check the quality of the power cord and other extension cable.
- Insert the selected accessory tightly into the end of the hose.



Only when all the motors are stopped can the machine be restarted.

Dustbin

- Disconnect the power before removing or installing the dustbin.
- Turn off the suction motor and the power of the machine.
- Open the ear-hanging groove of the motor head, remove the motor head and take out the dust compartment.

Maintenance

- Disconnect the power before any maintenance.
- Check whether the filter screen is worn.
- Check whether the sealing strips of the engine and the dustbin and the fixing ring of the filter screen are worn.
- Check whether the plug, the switch and the cable are worn or broken.
- Check whether all the nuts are tightened.
- Check whether the dustbin has been emptied. (The dustbin should be emptied every time it is three-quarters full.)
- Check whether the machine and all the accessories are complete.
- Check whether there are holes on the hose.



Maintenance must be realized by professional personnel.

Filter screen

If you need to replace the filter screen, follow the instructions below:

- Open the engine head; take out and replace the filter.
- Take out and replace the dust compartment.

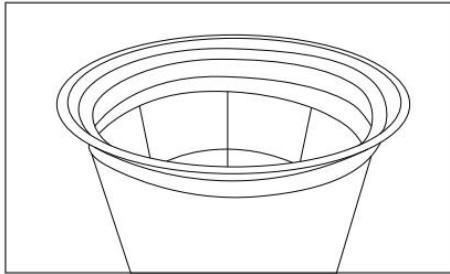

Common problems and solutions

Problem	Cause	Solution
The machine cannot be started.	The machine is powered-off.	Check whether the plug and the power cord are complete.
The machine leaks.	The hose is broken.	Replace the hose.
	The filter holes become larger	
	The filter screen is not suitable.	
The machine does not work normally.	The hose is blocked or broken.	Clean or replace the hose.
	The dustbin is filled.	Empty the dustbin.
	The filter screen is blocked.	Clean the filter screen.
	The sealing strips are worn.	Clean or replace the sealing strip.
Too much noise is produced.	Contact the original manufacturer or the distributor.	

After-sale services

1 General description

- Seven-day guaranteed return, fifteen-day guaranteed replacement, one-year warranty for the whole machine, 6-month warranty for damaged parts, and no warranty for consumables (calculated from the next day after receiving the machine).
- The delivery receipt and purchase invoice are certificates for warranty and must be kept properly.

2 Contents of warranty

Category	Contents	Warranty period
The entire machine	Sheet metal parts, batteries, motors, controllers, accelerator pedal, relay, charger, spray gun, high-pressure pump, brake assembly	1 year
Damaged parts	Shock attenuator, inner springs, wheels, nozzles, lights, bearings, universal wheels, fuses	6 months
Consumables	Side brush, main brush, filter element, baffle, conveyor belt, sealing strip, high pressure water pipe	No warranty

3 Cases not covered in the warranty

- The operator fails to perform maintenance according to the instruction manual, resulting in damage or failure.
- The surface and/or the structure of the machine are obviously damaged due to improper operation.
- Disassembly or modification not approved by the original manufacturer.
- Damage due to weather or force majeure.
- The warranty is expired or the machine has been used for more than 1,500 hours.

Warranty Card

用户名 User's name		联系电话 Tel	
通讯地址 Address		票据号 Bill No.	
购买时间 Date of purchase		机身编号 Serial number	
产品型号 Type of product		日期 Date	
更换配件： Accessories to be replaced:			
故障描述： Fault description:			

Anhui Chancee Technology Co., Ltd.
Direction: 11 Qiaowan Road, Heifei, Anhui, China
Website: www.chanceeglobal.com